

# Tektronix®

---

**AWG5200 Series  
Arbitrary Waveform Generators  
Installation and Safety Instructions**



071-3529-01

## 日图简介

深圳市日图科技有限公司（简称“日图科技”）创始于2004年，核心业务是为国内企业提供测试设备及相关器材的供应服务，公司客户涵盖制造、科研、教育、电力、能源、通信等众多领域。创业至今，日图科技已经成为国内仪器仪表行业中最大的综合服务供应商之一，日图科技作为行内的领先者，有着高效的供应服务体系，并拥有一支专业的、高素质的服务团队。

目前，日图科技已在深圳、上海、广州、苏州、重庆、杭州、西安、香港等国内电子工业发达地区设立了办事与服务机构，并通过日图科技在全国各地的经销网络，为广大客户提供优质的本地化服务。

日图科技一贯秉承“专业、规范、诚信立业，日日图新”的宗旨，并在实践中不断提升公司的服务能力，为客户提供专业、高效、全面、经济的优质供应服务，顾客满意是日图科技永远追求的目标。

## 合作伙伴



## 优势服务

- (1) 产品选型
- (2) 测试解决方案
- (3) 免费测试服务
- (4) 代办计量校准
- (5) 维修维护
- (6) 技术培训
- (7) 物流配送
- (8) 常备应急库存





**AWG5200 Series  
Arbitrary Waveform Generators  
Installation and Safety Instructions**

Copyright © Tektronix. All rights reserved. Licensed software products are owned by Tektronix or its subsidiaries or suppliers, and are protected by national copyright laws and international treaty provisions. Tektronix products are covered by U.S. and foreign patents, issued and pending. Information in this publication supersedes that in all previously published material. Specifications and price change privileges reserved.

TEKTRONIX and TEK are registered trademarks of Tektronix, Inc.

### **Contacting Tektronix**

Tektronix, Inc.  
14150 SW Karl Braun Drive  
P.O. Box 500  
Beaverton, OR 97077  
USA

For product information, sales, service, and technical support:

- In North America, call 1-800-833-9200.
- Worldwide, visit [www.tek.com](http://www.tek.com) to find contacts in your area.

## Warranty

Tektronix warrants that this product will be free from defects in materials and workmanship for a period of one (1) year from the date of shipment. If any such product proves defective during this warranty period, Tektronix, at its option, either will repair the defective product without charge for parts and labor, or will provide a replacement in exchange for the defective product. Parts, modules and replacement products used by Tektronix for warranty work may be new or reconditioned to like new performance. All replaced parts, modules and products become the property of Tektronix.

In order to obtain service under this warranty, Customer must notify Tektronix of the defect before the expiration of the warranty period and make suitable arrangements for the performance of service. Customer shall be responsible for packaging and shipping the defective product to the service center designated by Tektronix, with shipping charges prepaid. Tektronix shall pay for the return of the product to Customer if the shipment is to a location within the country in which the Tektronix service center is located. Customer shall be responsible for paying all shipping charges, duties, taxes, and any other charges for products returned to any other locations.

This warranty shall not apply to any defect, failure or damage caused by improper use or improper or inadequate maintenance and care. Tektronix shall not be obligated to furnish service under this warranty a) to repair damage resulting from attempts by personnel other than Tektronix representatives to install, repair or service the product; b) to repair damage resulting from improper use or connection to incompatible equipment; c) to repair any damage or malfunction caused by the use of non-Tektronix supplies; or d) to service a product that has been modified or integrated with other products when the effect of such modification or integration increases the time or difficulty of servicing the product.

THIS WARRANTY IS GIVEN BY TEKTRONIX WITH RESPECT TO THE PRODUCT IN LIEU OF ANY OTHER WARRANTIES, EXPRESS OR IMPLIED. TEKTRONIX AND ITS VENDORS DISCLAIM ANY IMPLIED WARRANTIES OF MERCHANTABILITY OR FITNESS FOR A PARTICULAR PURPOSE. TEKTRONIX' RESPONSIBILITY TO REPAIR OR REPLACE DEFECTIVE PRODUCTS IS THE SOLE AND EXCLUSIVE REMEDY PROVIDED TO THE CUSTOMER FOR BREACH OF THIS WARRANTY. TEKTRONIX AND ITS VENDORS WILL NOT BE LIABLE FOR ANY INDIRECT, SPECIAL, INCIDENTAL, OR CONSEQUENTIAL DAMAGES IRRESPECTIVE OF WHETHER TEKTRONIX OR THE VENDOR HAS ADVANCE NOTICE OF THE POSSIBILITY OF SUCH DAMAGES.

[W2 – 15AUG04]



---

# Table of Contents

Important safety information .....	iii
General safety summary .....	iii
Terms in the manual .....	iv
Terms on the product .....	v
Symbols on the product .....	v
Compliance Information .....	vii
EMC compliance .....	vii
Safety compliance .....	viii
Environmental compliance .....	ix

## Preface

Key features .....	1
Documentation .....	1
Conventions used in this manual .....	2

## Install the instrument

Standard accessories .....	3
Recommended accessories .....	4
Product options .....	4
Product upgrades .....	5
ReplaceableParts .....	6
Operating requirements .....	6
Environmental requirements .....	7
Power supply requirements .....	7
Cleaning .....	7
Power on the instrument .....	8
Power off the instrument .....	9
Inspect the instrument .....	9
Self calibration .....	10
Connecting to the instrument .....	12
Connecting to a network .....	12
Connecting peripheral devices .....	12
Controlling the instrument using a remote PC .....	12
Preventing instrument damage .....	12
Overheat protection .....	12
Connectors .....	13

External device connections .....	13
Enhancements for your instrument .....	13
View installed licenses .....	14
Install a new license .....	14
Windows interface guidelines .....	15

## Operation basics

AWG mode general overview .....	17
Functions mode general overview .....	19
Front-panel connectors .....	21
Front-panel controls .....	22
Rear-panel connectors .....	23
Touchscreen interface .....	24
Run state control .....	25
Run state status indicators (screen PlayStop button) .....	25
Run state status indicators (front-panel PlayStop button) .....	25
Run mode .....	26
Changing control settings .....	26
Preferences .....	26
System .....	27
Basic guidelines to play a waveform .....	28

## Restoring software

Restoring instrument operating system and product software .....	29
Internal recovery utility .....	29
AWG5200 Series product software upgrade .....	30



# Important safety information

This manual contains information and warnings that must be followed by the user for safe operation and to keep the product in a safe condition.

## General safety summary

Use the product only as specified. Review the following safety precautions to avoid injury and prevent damage to this product or any products connected to it. Carefully read all instructions. Retain these instructions for future reference.

Comply with local and national safety codes.

For correct and safe operation of the product, it is essential that you follow generally accepted safety procedures in addition to the safety precautions specified in this manual.

The product is designed to be used by trained personnel only.

Only qualified personnel who are aware of the hazards involved should remove the cover for repair, maintenance, or adjustment.

Before use, always check the product with a known source to be sure it is operating correctly.

This product is not intended for detection of hazardous voltages.

Use personal protective equipment to prevent shock and arc blast injury where hazardous live conductors are exposed.

While using this product, you may need to access other parts of a larger system. Read the safety sections of the other component manuals for warnings and cautions related to operating the system.

When incorporating this equipment into a system, the safety of that system is the responsibility of the assembler of the system.

## To avoid fire or personal injury

**Use proper power cord.** Use only the power cord specified for this product and certified for the country of use.

**Ground the product.** This product is grounded through the grounding conductor of the power cord. To avoid electric shock, the grounding conductor must be connected to earth ground. Before making connections to the input or output terminals of the product, ensure that the product is properly grounded. Do not disable the power cord grounding connection.

**Power disconnect.** The power cord disconnects the product from the power source. See instructions for the location. Do not position the equipment so that it is difficult to operate the power cord; it must remain accessible to the user at all times to allow for quick disconnection if needed.

**Observe all terminal ratings.** To avoid fire or shock hazard, observe all rating and markings on the product. Consult the product manual for further ratings information before making connections to the product.

Do not apply a potential to any terminal, including the common terminal, that exceeds the maximum rating of that terminal.

**Do not operate without covers.** Do not operate this product with covers or panels removed, or with the case open. Hazardous voltage exposure is possible.

**Avoid exposed circuitry.** Do not touch exposed connections and components when power is present.

**Do not operate with suspected failures.** If you suspect that there is damage to this product, have it inspected by qualified service personnel.

Disable the product if it is damaged. Do not use the product if it is damaged or operates incorrectly. If in doubt about safety of the product, turn it off and disconnect the power cord. Clearly mark the product to prevent its further operation.

Examine the exterior of the product before you use it. Look for cracks or missing pieces.

Use only specified replacement parts.

**Do not operate in wet/damp conditions.** Be aware that condensation may occur if a unit is moved from a cold to a warm environment.

**Do not operate in an explosive atmosphere.**

**Keep product surfaces clean and dry.** Remove the input signals before you clean the product.

**Provide proper ventilation.** Refer to the installation instructions in the manual for details on installing the product so it has proper ventilation.

Slots and openings are provided for ventilation and should never be covered or otherwise obstructed. Do not push objects into any of the openings.

**Provide a safe working environment.** Always place the product in a location convenient for viewing the display and indicators.

Avoid improper or prolonged use of keyboards, pointers, and button pads. Improper or prolonged keyboard or pointer use may result in serious injury.

Be sure your work area meets applicable ergonomic standards. Consult with an ergonomics professional to avoid stress injuries.

Use care when lifting and carrying the product. This product is provided with a handle or handles for lifting and carrying.

Use only the Tektronix rackmount hardware specified for this product.

## Terms in the manual

These terms may appear in this manual:



---

**WARNING.** Warning statements identify conditions or practices that could result in injury or loss of life.

---



---

**CAUTION.** Caution statements identify conditions or practices that could result in damage to this product or other property.

---

## Terms on the product

These terms may appear on the product:

- DANGER indicates an injury hazard immediately accessible as you read the marking.
- WARNING indicates an injury hazard not immediately accessible as you read the marking.
- CAUTION indicates a hazard to property including the product.

## Symbols on the product



When this symbol is marked on the product, be sure to consult the manual to find out the nature of the potential hazards and any actions which have to be taken to avoid them. (This symbol may also be used to refer the user to ratings in the manual.)

The following symbols may appear on the product:



CAUTION  
Refer to Manual



Protective Ground  
(Earth) Terminal



Chassis Ground



Standby



---

# Compliance Information

This section lists the EMC (electromagnetic compliance), safety, and environmental standards with which the instrument complies.

## EMC compliance

### EU EMC Directive

Meets intent of Directive 2014/30/EU for Electromagnetic Compatibility. Compliance was demonstrated to the following specifications as listed in the Official Journal of the European Communities:

**EN 61326-1.** EMC requirements for electrical equipment for measurement, control, and laboratory use.<sup>1 2 3</sup>

- CISPR 11. Radiated and conducted emissions, Group 1, Class A
- IEC 61000-4-2. Electrostatic discharge immunity
- IEC 61000-4-3. RF electromagnetic field immunity
- IEC 61000-4-4. Electrical fast transient / burst immunity
- IEC 61000-4-5. Power line surge immunity
- IEC 61000-4-6. Conducted RF immunity
- IEC 61000-4-8. Power frequency magnetic field immunity test
- IEC 61000-4-11. Voltage dips and interruptions immunity

**EN 61000-3-2.** AC power line harmonic emissions

**EN 61000-3-3.** Voltage changes, fluctuations, and flicker

**European contact.** Mfr. Compliance Contact

Tektronix, Inc. PO Box 500, MS 19-045

Beaverton, OR 97077, USA

### Australia / New Zealand Declaration of Conformity – EMC

Complies with the EMC provision of the Radiocommunications Act per the following standard, in accordance with ACMA:

- EN 61326-1. Radiated and conducted emissions, Group 1, Class A.

---

<sup>1</sup> This product is intended for use in nonresidential areas only. Use in residential areas may cause electromagnetic interference.

<sup>2</sup> Emissions which exceed the levels required by this standard may occur when this equipment is connected to a test object.

<sup>3</sup> For compliance with the EMC standards listed here, high quality shielded interface cables should be used.

## Safety compliance

This section lists the safety standards with which the product complies and other safety compliance information.

### EU low voltage directive

Compliance was demonstrated to the following specification as listed in the Official Journal of the European Union:

Low Voltage Directive 2014/35/EU.

- EN 61010-1. Safety Requirements for Electrical Equipment for Measurement, Control, and Laboratory Use – Part 1: General Requirements.

### U.S. nationally recognized testing laboratory listing

- UL 61010-1. Safety Requirements for Electrical Equipment for Measurement, Control, and Laboratory Use – Part 1: General Requirements.

### Canadian certification

- CAN/CSA-C22.2 No. 61010-1. Safety Requirements for Electrical Equipment for Measurement, Control, and Laboratory Use – Part 1: General Requirements.

### Additional compliances

- IEC 61010-1. Safety Requirements for Electrical Equipment for Measurement, Control, and Laboratory Use – Part 1: General Requirements.

### Equipment type

Test and measuring equipment.

### Safety class

Class 1 – grounded product.

### Pollution degree description

A measure of the contaminants that could occur in the environment around and within a product. Typically the internal environment inside a product is considered to be the same as the external. Products should be used only in the environment for which they are rated.

- Pollution Degree 1. No pollution or only dry, nonconductive pollution occurs. Products in this category are generally encapsulated, hermetically sealed, or located in clean rooms.
- Pollution Degree 2. Normally only dry, nonconductive pollution occurs. Occasionally a temporary conductivity that is caused by condensation must be expected. This location is a typical office/home environment. Temporary condensation occurs only when the product is out of service.
- Pollution Degree 3. Conductive pollution, or dry, nonconductive pollution that becomes conductive due to condensation. These are sheltered locations where neither temperature nor humidity is controlled. The area is protected from direct sunshine, rain, or direct wind.
- Pollution Degree 4. Pollution that generates persistent conductivity through conductive dust, rain, or snow. Typical outdoor locations.

### Pollution degree

Pollution Degree 2 (as defined in IEC 61010-1). Note: Rated for indoor, dry location use only.

### IP rating

IP20 (as defined in IEC 60529).

### Measurement and overvoltage category descriptions

Measurement terminals on this product may be rated for measuring mains voltages from one or more of the following categories (see specific ratings marked on the product and in the manual).

- Measurement Category II. For measurements performed on circuits directly connected to the low-voltage installation.
- Measurement Category III. For measurements performed in the building installation.
- Measurement Category IV. For measurements performed at the source of low-voltage installation.

---

**NOTE.** Only mains power supply circuits have an overvoltage category rating. Only measurement circuits have a measurement category rating. Other circuits within the product do not have either rating.

---

### Mains overvoltage category rating

Overvoltage Category II (as defined in IEC 61010-1)

## Environmental compliance

This section provides information about the environmental impact of the product.

### Product end-of-life handling

Observe the following guidelines when recycling an instrument or component:

**Equipment recycling.** Production of this equipment required the extraction and use of natural resources. The equipment may contain substances that could be harmful to the environment or human health if improperly handled at the product's end of life. To avoid release of such substances into the environment and to reduce the use of natural resources, we encourage you to recycle this product in an appropriate system that will ensure that most of the materials are reused or recycled appropriately.



This symbol indicates that this product complies with the applicable European Union requirements according to Directives 2012/19/EU and 2006/66/EC on waste electrical and electronic equipment (WEEE) and batteries. For information about recycling options, check the Tektronix Web site .

**Perchlorate materials.** This product contains one or more type CR lithium batteries. According to the state of California, CR lithium batteries are classified as perchlorate materials and require special handling. See [www.dtsc.ca.gov/hazardouswaste/perchlorate](http://www.dtsc.ca.gov/hazardouswaste/perchlorate) for additional information.





# Preface

This manual describes the installation and basic operation of AWG5200 series instruments. For additional operating information, refer to the instrument help on your instrument. The following instruments are supported by this document:

- AWG5202 two channel Arbitrary Waveform Generators
- AWG5204 four channel Arbitrary Waveform Generators
- AWG5208 eight channel Arbitrary Waveform Generators

## Key features

The following list describes some of the key features of the AWG5200 series instruments:

- Two modes of operation:
  - AWG mode (Arbitrary Waveform Generator) to play any waveshape from a file
  - Functions mode to play basic waveshapes
- Up to 5 GS/s sample rate (10 GS/s with 2x interpolation)
- 2 GSamples waveform memory per channel
- Sequencing (with SEQ license)
- -70 dBc Spurious Free Dynamic Range
- 16 bit vertical resolution
- IQ waveform digital up-conversion (with DIGUP license)
- Synchronize multiple instruments to achieve a multi-channel high speed AWG system
- An intuitive, graphical user interface
- Removable hard disk drive
- Supports USB 2.0 interface (front) and USB 3.0 interface (rear)
- LAN (1000/100/10 Base-T)
- Capacitive touchscreen user interface
- Microsoft Windows® 64-bit operating system

## Documentation

Review the following table to locate more information about this product.

To read about	Use these documents	Tektronix part number
Installation and operation (overviews)	Installation and Safety manual.	071-3529-xx
Operation and user interface	Instrument help from the Help menu.	--
	A printable version of this help system is available on the Tektronix Web site ( <a href="http://www.tektronix.com/manuals">www.tektronix.com/manuals</a> ).	077-1334-xx

To read about	Use these documents	Tektronix part number
Programmer commands	Programmer manual. This manual is available on the Tektronix Web site ( <a href="http://www.tektronix.com/manuals">www.tektronix.com/manuals</a> ).	077-1337-xx
Specifications and performance verification procedures	Specifications and Performance Verification Technical Reference. This manual is available on the Tektronix Web site ( <a href="http://www.tektronix.com/manuals">www.tektronix.com/manuals</a> ).	077-1335-xx
Installing the instrument in an equipment rack	Rackmount kit instructions	071-3534-xx

## Conventions used in this manual

The following icons are used throughout this manual.

Step	Front panel power	Connect power	Network	SVGA	USB
1					

# Install the instrument

Unpack the instrument and check that you received all items listed as Standard Accessories. Check the Tektronix Web site ([www.tektronix.com](http://www.tektronix.com)) for the most current information.

## Standard accessories

Accessory	Tektronix part number
AWG5200 Series Installation and Safety Manual	
English (Option L0)	071-3529-xx
Japanese (Option L5)	071-3530-xx
Simplified Chinese (Option L7)	071-3531-xx
Traditional Chinese (Option L8)	071-3533-xx
Russian (Option L10)	071-3532-xx
50 $\Omega$ SMA Termination, Male, DC to 18 GHz	136-7162-xx Two per channel
Power cord – one of the following:	
North America (Option A0)	
Universal Euro (Option A1)	
United Kingdom (Option A2)	
Australia (Option A3)	
Switzerland (Option A5)	
Japan (Option A6)	
China (Option A10)	
India (Option A11)	
No power cord or AC adapter (Option A99)	

## Recommended accessories

Accessory		Part number
GPIB to USB Adapter	Enables GPIB control through USB B port	TEK-USB-488
Power Splitters	1.5 kHz - 18 GHz	Mini-Circuits ZX10-2-183-S +
	DC-18 GHz	Picosecond Pulse Labs 5331
Amplifiers	2.5 kHz - 10 GHz, 26 dB gain	RF-Lambda RAMP00G20GA
	0.01 - 20 GHz, 30 dB gain	Mouser 565-72979
Rack mount kit	Enables installation into an equipment rack	GF-RACK3U

## Product options

Instrument	Option	Description
AWG5202		16 bit, 2 GSamples/channel record length, 2-channel arbitrary waveform generator
	AWG5200-225	2.5 GS/s
	AWG5200-250	5 GS/s (10 GS/s interpolated)
	AWG5200-2DC	High Bandwidth Amplified outputs
	AWG5200-2DIGUP	Digital up conversion (requires AWG5200-250)
	AWG5200-2AC	AC Amplified outputs
	AWG5200-SEQ	Sequencing
	AWG5202-ACCY01	USB mouse, compact USB keyboard, touch screen stylus
	AWG5200-SSD	Additional (or replacement) preprogrammed solid state drive
AWG5204		16 bit, 2 GSamples/channel record length, 4-channel arbitrary waveform generator
	AWG5200-425	2.5 GS/s
	AWG5200-450	5 GS/s (10 GS/s interpolated)
	AWG5200-4DC	High Bandwidth Amplified outputs
	AWG5200-4DIGUP	Digital up conversion (requires AWG5200-450)
	AWG5200-4AC	AC Amplified outputs
	AWG5200-SEQ	Sequencing
	AWG5204-ACCY01	USB mouse, compact USB keyboard, touch screen stylus
	AWG5200-SSD	Additional (or replacement) preprogrammed solid state drive

Instrument	Option	Description
AWG5208		16 bit, 2 GSamples/channel record length, 8-channel arbitrary waveform generator
	AWG5200-825	2.5 GS/s
	AWG5200-850	5 GS/s (10 GS/s interpolated)
	AWG5200-8DC	High Bandwidth Amplified outputs
	AWG5200-8DIGUP	Digital up conversion (requires AWG5200-850)
	AWG5200-8AC	AC Amplified outputs
	AWG5200-SEQ	Sequencing
	AWG5208-ACCY01	USB mouse, compact USB keyboard, touch screen stylus
	AWG5200-SSD	Additional (or replacement) preprogrammed solid state drive

## Product upgrades

Upgrades	Description
AWG5202	
AWG52UP Opt SSD	Provides an additional (or replacement) preprogrammed solid state drive
AWG5200-2-2550	Increases sampling rate from 2.5 GS/s to 5 GS/s (10 GS/s interpolated)
AWG5200-2DC	Adds DC High Bandwidth Amplified outputs
AWG5200-2AC	Adds AC Amplified outputs
AWG5200-2DIGUP	Adds digital up conversion (requires AWG5200-250 or AWG5200-2-2550)
AWG5200-SEQ	Adds Sequencing
AWG5204	
AWG52UP Opt SSD	Provides an additional (or replacement) preprogrammed solid state drive
AWG5200-4-2550	Increases sampling rate from 2.5 GS/s to 5 GS/s (10 GS/s interpolated)
AWG5200-4DC	Adds DC High Bandwidth Amplified outputs
AWG5200-4AC	Adds AC Amplified outputs
AWG5200-4DIGUP	Adds digital up conversion (requires AWG5200-450 or AWG5200-4-2550)
AWG5200-SEQ	Adds Sequencing
AWG5208	
AWG52UP Opt SSD	Provides an additional (or replacement) preprogrammed solid state drive
AWG5200-8-2550	Increases sampling rate from 2.5 GS/s to 5 GS/s (10 GS/s interpolated)
AWG5200-8DC	Adds DC High Bandwidth Amplified outputs
AWG5200-8AC	Adds AC Amplified outputs
AWG5200-8DIGUP	Adds digital up conversion (requires AWG5200-850 or AWG5200-8-2550)
AWG5200-SEQ	Adds Sequencing

## Replaceable Parts

Item	Tektronix part number
Rear panel foot (four per instrument)	348-2037-xx
Screw	211-1481-xx
Front bottom flip-foot (two per instrument)	348-1950-xx
Screw (one per foot)	211-1459-xx
Foot cushion (one per foot)	348-2199-xx
Rear bottom foot (two per instrument)	348-1948-xx
Screw (one per foot)	211-1459-xx
Foot cushion (one per foot)	348-1947-xx
Front handle (two per instrument)	367-0599-xx
Screw (three per handle)	211-1645-xx
Side handle (one per instrument)	367-0603-xx
Spacer (two - one on each end)	407-5992-xx
Top cap (two - one on each end)	407-5991-xx
Screw (two - one on each end)	211-1645-xx

## Operating requirements

Place the instrument on a cart or bench, observing clearance requirements:

- Top and bottom: 0 cm (0 in)
- Left and right side: 5.08 cm (2 in)
- Rear: 0 cm (0 in)



**CAUTION.** To ensure proper cooling, keep sides of the instrument clear of obstructions.

## Environmental requirements

The environmental requirements for your instrument are listed in the following table. For instrument accuracy, ensure that the instrument has warmed up for 20 minutes and meets the environmental requirements listed in the following table.

Requirement	Description
Temperature (operating)	0 °C to 50 °C (+32 °F to +122 °F)
Humidity (operating)	5% to 90% relative humidity at up to 30 °C (86 °F) 5% to 45% relative humidity above 30 °C (86 °F) up to +50 °C (122 °F) noncondensing
Altitude (operating)	Up to 3,000 m (9,843 feet)

## Power supply requirements

The power supply requirements for your instrument are listed in the following table.



**WARNING.** To reduce the risk of fire and shock, ensure that the mains supply voltage fluctuations do not exceed 10% of the operating voltage range.

Source Voltage and Frequency	Power Consumption
100 VAC to 240 VAC, 50/60 Hz	750 W

## Cleaning

Inspect the arbitrary waveform generator as often as operating conditions require. Follow these steps to clean the exterior surface.



**WARNING.** To avoid personal injury, power off the instrument and disconnect it from line voltage before performing any of the following procedures.



**CAUTION.** To avoid damage to the surface of the instrument, do not use any abrasive or chemical cleaning agents. Use extreme care when cleaning the surface of the display. The display is easily scratched if excessive force is used.

1. Remove loose dust on the outside the instrument with a lint-free cloth. Use care to avoid scratching the front-panel display.
2. Use a soft cloth dampened with water to clean the instrument. If needed, use a 75% isopropyl alcohol solution as a cleaner. Do not spray liquids directly on the instrument.

## Power on the instrument

1. Connect the AC power cord to the rear of the instrument.

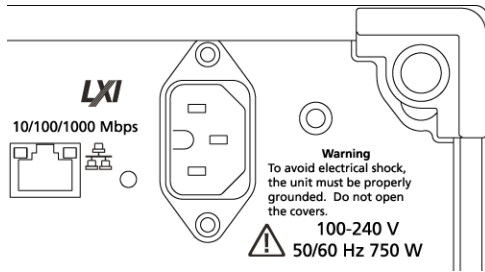

2. Use the front-panel power button to switch the instrument on.



The power button indicates four instrument power states:

- No light – no power applied
- Yellow – standby mode
- Green – powered on
- Flashing Red – over heat condition (instrument shuts down and cannot restart until internal temperature returns to a safe level)



## Power off the instrument

1. Press the front-panel power button to shut down the instrument.

The shutdown process takes approximately 30 seconds to complete, placing the instrument in standby mode. Alternatively, use the Windows Shutdown menu.

---

**NOTE.** You can force an immediate shutdown by pressing and holding the power button for four seconds. Unsaved data is lost.

---



2. To completely remove power to the instrument, perform the shutdown just described, and then remove the power cord from the instrument.

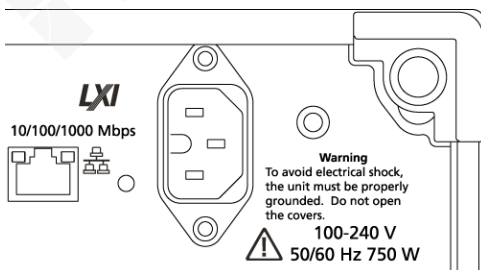

## Inspect the instrument

Two types of diagnostics are provided to verify the functionality of your instrument:

- Power-on self test (POST) – Every time you power on the instrument, the instrument automatically performs the POST internal diagnostics.
- Diagnostics from the System menu – You can run the internal diagnostics from the System menu. Use the following procedure:
  1. Select **Utilities** from the workspace tabs, then the **Diag & Cal** button.
  2. Click **Diagnostics & Calibration**.
  3. In the Diagnostics and Calibration screen, click **Diagnostics**.
  4. Choose the set of diagnostics you want to run.
    - **POST Only:** Offers a set of tests that automatically run at power on (Power On Self Test). These diagnostic selections verify such things as internal device communications, system memory, and real-time clock.

- **Full diagnostics:** Provides access to all diagnostic self tests the instrument is able to run.

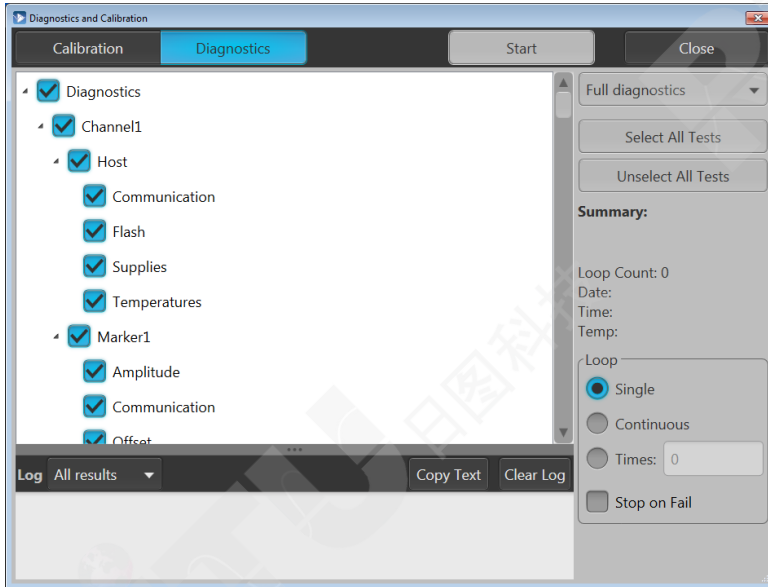

5. Select and deselect each test individually or use the **Select all tests** and **Unselect all tests** buttons.
6. Select the desired **Loop** function.
  - **Single** makes one pass through the selected tests.
  - **Continuous** continually runs through the selected tests until aborted.
  - **Times** lets you define how many times to run the selected tests.
  - **Stop on Fail** stops the diagnostics if a selected test fails, regardless of the Loop selection.
7. Click **Start** to run the diagnostics. The **Start** button changes to **Abort** while tests are actively running.

Verify that the instrument passes all tests. If diagnostic failures occur, contact your local Tektronix service personnel.

## Self calibration

The self calibration uses internal calibration routines that adjust the internal calibration constants as necessary.

If the instrument detects an internal temperature difference of more than 6 °C from its previous calibration, a message is displayed in the status area (at the bottom of the screen), recommending a self calibration. You can perform the self calibration at anytime.

Changes in operating temperature can affect hardware performance, so if your application requires optimum performance, you should run the self-calibration utility before performing critical tests.

---

**NOTE.** Always power on the instrument for at least 20 minutes before performing a self calibration. See [Operating requirements](#) on page 6.

---

1. Confirm that there is no output signal. The front-panel **Play/Stop** button indicator is off.



2. Click **Utilities** from the workspace tabs, then click **Diag & Cal**.

3. Click **Diagnostics & Calibration**.

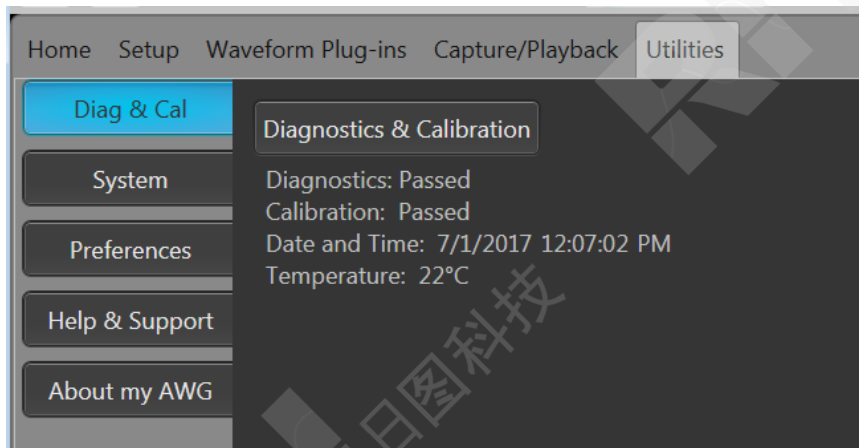

4. In the **Diagnostics and Calibration** screen, click **Calibration**.

All calibration routines are selected by default and cannot be deselected.

5. Click **Start**.

The **Start** button changes to **Abort** once the calibration has started. Clicking **Abort** stops the calibration process and restores all values to their previous state. All calibration items should indicate Pass. If not, contact your local Tektronix service personnel.

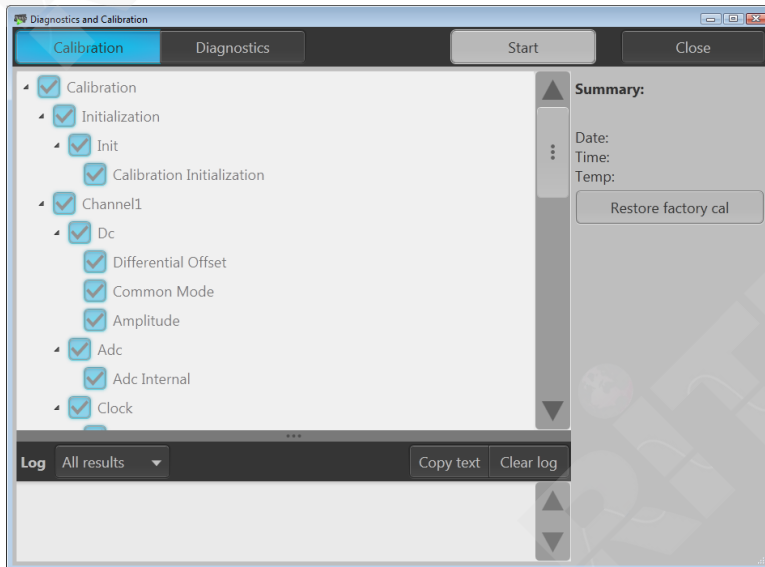

## Connecting to the instrument

### Connecting to a network

You can connect your instrument to a network for file sharing, printing, Internet access, and other functions. Consult your network administrator and use the standard Windows utilities to configure the instrument for your network.

### Connecting peripheral devices

You can connect peripheral devices to your instrument, such as a keyboard and mouse (provided). A mouse and keyboard can substitute for the touchscreen and are particularly helpful for opening and saving files.

## Controlling the instrument using a remote PC

Use your PC to control the arbitrary waveform generator through a LAN using the Windows Remote Desktop function. If your PC has a larger screen, it will be easier to see details such as zooming waveforms or making cursor measurements. You can also use a third party software application (installed on your PC) to create a waveform and import it through a network.

## Preventing instrument damage

### Overheat protection

The instrument is protected against overheating damage by continuously monitoring the internal temperature. If the internal temperature exceeds the maximum rated operating range, two actions occur.

- The instrument shuts down.
- The Power button flashes red.

---

**NOTE.** An indication that the internal temperature is escalating is continual calibration warnings due to temperature change.

---

If an overheat condition was detected, the power button will continue to flash red, even after the instrument cools (unless power is disconnected). This is done to indicate that an overheat condition has occurred, regardless of how much time has passed.

Restarting the instrument (or removing and reapplying power) will stop the power button from flashing red. But if the overheat condition still remains while attempting to restart the instrument, the power button may immediately (or in a short time) start flashing red again and the instrument will shut down.

Common causes of overheating include:

- The ambient temperature requirement is not being met.
- The required cooling clearance is not being met.
- One or more instrument fans are not working properly.

## Connectors

The arbitrary waveform generator has both output and input connectors. Do not apply external voltage to any output connector and ensure proper restrictions are met for any input connector.



**CAUTION.** Always turn off the signal outputs when you connect or disconnect cables to/from the signal output connectors. If you connect a (Device Under Test) DUT while the instrument signal outputs are in the On state, it may cause damage to the instrument or to the DUT.

## External device connections

For many applications, powered external devices may need to be used on the output of the AWG. These may include Bias-Ts, Amplifiers, transformers etc. It is important to guarantee that these components are adaptable for the specific AWG and that they are configured as required by the device manufacturer.

**NOTE.** The term Device means external powered devices such as bias-t, whereas Device Under Test (DUT) refers to the circuit being tested.

It is critical that there is minimal inductive kickback into the AWG output when the device is connected or disconnected. Inductive kickback can occur if the external device can hold a charge and then discharge when a ground path becomes available such a connection to the output termination of the AWG channel output. To minimize this inductive kickback care should be taken before connecting the device to the AWG output.

Some simple guidelines to follow for device connection are:

1. Always use a grounded wrist strap when connecting cables.
2. Make sure the power supply to the device is turned off or unplugged.
3. Establish ground connection between the device and AWG test system.
4. Make sure the DUT's power supply is turned off or set at 0 volts.
5. Discharge cables to ground before connecting to the AWG.
6. Engage connector between device and AWG output.
7. Power up device power supply.
8. Set device voltage power supply (bias level voltage for bias-t) to desired voltage.
9. Power up DUT power supply.

## Enhancements for your instrument

Upgrades and plug-ins purchased with your instrument are pre-installed. You can view these by going to **Utilities > About my AWG**. If you purchase an upgrade or plug-in after you've received your instrument, you may need to install a license key to activate the feature. Use the **Install Licenses** dialog box to enable the upgrades that you purchased from Tektronix for your instrument. For the most current list of upgrades, go to [www.tektronix.com](http://www.tektronix.com) or contact your local Tektronix representative.

Your instrument can be enhanced by several different methods:

- Software enhancements: Enhancements ordered at the time of your purchase are pre-installed. These can also be purchased post sales and may require the installation of software in addition to installing a license to activate.
- Hardware enhancements: Features that require/enable hardware on the instrument. These can be ordered with the purchase of the instrument or as a post-purchase addition.
- Plug-ins: Applications that enhance a host application. Plug-ins designed to operate with an AWG5200 series instrument are also able to operate with the SourceXpress Waveform Creation software. Plug-ins with a floating license can be moved between instruments or SourceXpress.

## View installed licenses

1. Select **Utilities** from the workspace tabs.
2. Select **About my AWG** to display the current license information and system information.
3. The Installed Licenses dialog box displays the currently installed licenses on the instrument.

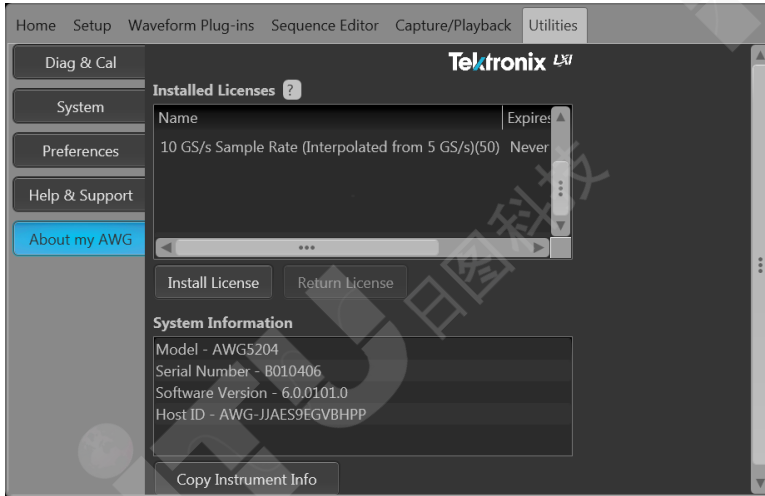

4. If you have a new license to install (to enable a new feature), click **Install Licenses** to start the installation process.

## Install a new license

Before starting this procedure, place the new license key (received from Tektronix) in a location you can access from the instrument. This can be anywhere on the instrument's C: drive or available networks. You can also use a USB flash drive to store your license.

1. Select **About my AWG** located in the Utilities tab.
2. Select the Install License button to display the license file selection screen and browse to the location where you've stored the license file.

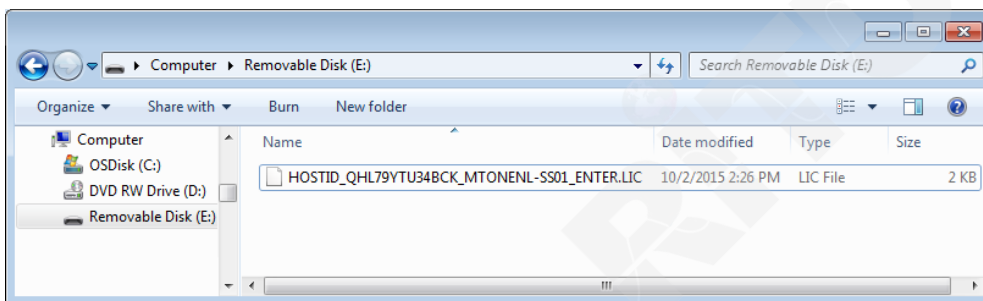

3. Select the license file and select Open.
4. After the successful installation is finished, the name of the licensed feature is listed along with the expiration date and time.

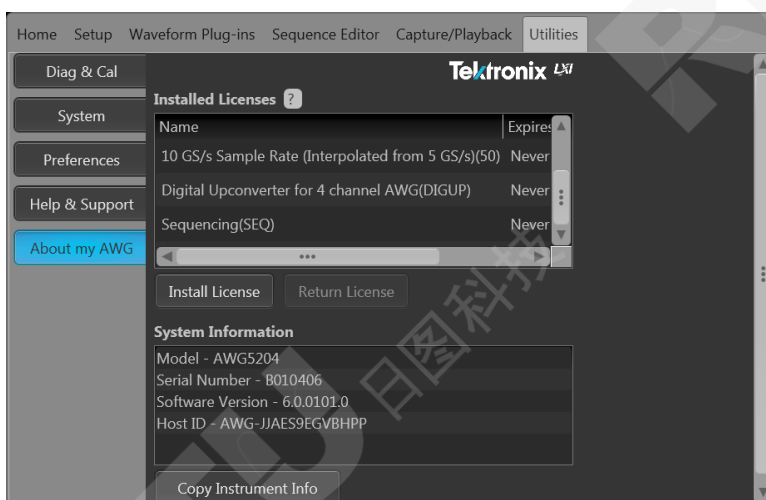

Floating licenses display the expiration date for that application. The expiration date for a floating license is defined when the license is checked out from the Tektronix Asset Management system. After the license expires, the application is automatically disabled and the license on the TekAMS is free to be assigned to a different host.

Node locked license have no expiration date.

## Windows interface guidelines

Because the instrument uses the Microsoft Windows interface, you have open access to the Windows operating system. You can access the Windows desktop to load and run other Windows-based applications such as Microsoft Excel.

Follow these guidelines to avoid making operating system changes that might cause problems while using the instrument:

- Be careful when making changes in the Control Panel. Avoid making changes to any controls with which you are unfamiliar.
- Do not delete or change any system fonts; this can affect the quality of the display.
- Be careful when making changes to the system Display properties. Changing settings such as resolution, text size, fonts, and orientation affects the usability of the display and the touchscreen.
- Do not change the contents of the Windows folder or the Program Files\Tektronix\AWG5200\ folder.
- Do not change the BIOS settings; this can affect the overall operation of the instrument.





# Operation basics

## AWG mode general overview

The following illustration and table provide a high-level overview of the AWG mode.

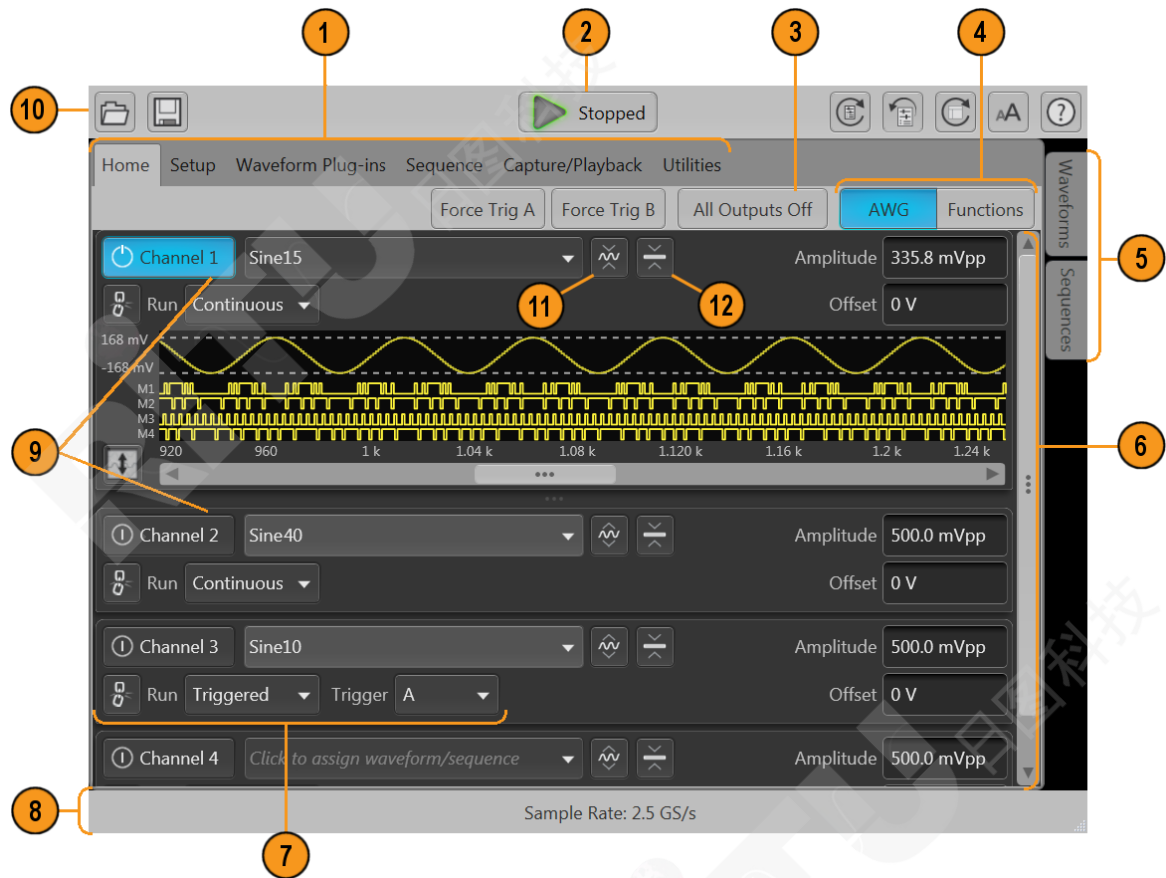

Screen element	Description
1. Workspace tabs	<p>The workspace tabs provide access to all of the instrument functions.</p> <ul style="list-style-type: none"> <li>■ Home returns the workspace area to the channel plot display.</li> <li>■ Setup displays the setup controls for channels, clock, triggers, and auxiliary outputs.</li> <li>■ Waveform Plug-ins displays the user interface for the selected plug-in.</li> <li>■ Sequence displays the workspace area to create waveform sequences (requires license).</li> <li>■ Capture/Playback displays the workspace area to import baseband I/Q data files and compile them into a waveform for payout.</li> <li>■ Utilities displays controls for system information (including diagnostics and calibration), preferences, help and support. Utilities are global instrument settings that are maintained in non-volatile memory when the application is closed or the instrument powered off. These settings are not saved and recalled with setup files nor are they impacted by restoring the default setup.</li> </ul>
2. Play/Stop button	<p>Starts and stops playing the waveform. The Play button icon changes to indicate the play status of the waveform. See <a href="#">Run state control</a> on page 25. When a waveform is playing, it is only present at the output connectors if the following conditions are met.</p> <ul style="list-style-type: none"> <li>■ The channel is enabled.</li> <li>■ The All Outputs Off is not active (outputs are connected).</li> </ul>
3. All outputs off	<p>The All Outputs Off button provides a quick disconnect of the analog and marker outputs, whether those outputs are enabled or not. (All Outputs Off overrides the channel output enable controls.) The outputs are electrically disconnected. When the All Outputs Off is disabled, the outputs return to their defined state.</p>
4. Mode selection	<p>Switches the instrument mode between AWG (arbitrary waveform generator) and Functions (basic waveshape generator). Mode selection is available from the Home tab in both the AWG mode and the Functions mode.</p>
5. Waveforms and sequences	<p>Contains all waveforms and sequences available for payout. Touch and hold (or right-mouse click) a waveform or sequence name to display menu selections to manage the lists. Sequencing must be licensed.</p>
6. Workspace	<p>The workspace area shows the contents of the selected tab (such as: Home, Settings).</p>
7. Trigger controls	<p>The Trigger controls provide access to the trigger settings.</p> <ul style="list-style-type: none"> <li>■ Use Run mode to set the trigger type.</li> <li>■ Use Trigger source for external triggering.</li> <li>■ Use the couple icon to couple the trigger settings for all channels.</li> </ul>
8. Status bar	<p>The status bar displays various user messages and status indicators.</p>
9. Channel enable	<p>Enables the channel output. Internally connects the channel and marker output connectors to the instrument. The All Outputs Off feature overrides the channel enable control.</p>

Screen element	Description
10. Toolbar	Tools are used to: <ul style="list-style-type: none"> <li>■ Display the instrument help.</li> <li>■ Restore the display to the default layout.</li> <li>■ Restore the default setup.</li> <li>■ Restore the most recently used setup.</li> <li>■ Open files (setup files, waveform files, sequence files).</li> <li>■ Save the current setup.</li> <li>■ Toggle the font size.</li> </ul>
11. Waveform display	Toggles the channel's waveform plot display on or off.
12. Channel settings display	Shows or hides additional channel controls.

## Functions mode general overview

The Functions interface provides you with a quick and easy way to generate simple types of waveforms. Refer to the following illustration and table for information on the key screen elements.



Screen element	Description
2. Play/Stop button	Starts and stops waveform play out. The Play button icon changes to indicate the waveform play out status. See <a href="#">Run state control</a> on page 25.
1. Workspace tabs	The workspace tabs provides access to all instrument functions. <ul style="list-style-type: none"> <li>■ Home returns the workspace area to the Function mode setup display.</li> <li>■ Utilities displays controls for preferences, system information, help and support. Utilities are global instrument settings.</li> </ul>
7. Channel controls	Select, enables, set the channel output path. Internally connects the channel and marker output connectors to the instrument. The All Outputs Off feature overrides the channel enable control.
4. Mode selection	Switches the instrument mode between AWG (arbitrary waveform generator) and Functions (basic waveshape generator). Mode selection is available from the Home tab in both the AWG mode and the Functions mode.
5. Workspace	The workspace area shows the parameters of the selected waveform type.
3. All outputs off	The All Outputs Off button provides a quick disconnect of the analog and marker outputs, whether those outputs are enabled or not. (All Outputs Off overrides the output enable controls.) The outputs are electrically disconnected. When the All Outputs Off is disabled, the outputs return to their defined state.
6. Status bar	The status bar displays various user messages and status indicators.
8. Toolbar	Tools are used to: <ul style="list-style-type: none"> <li>■ Display the instrument help.</li> <li>■ Restore the display to the default layout.</li> <li>■ Restore the default setup.</li> <li>■ Restore the most recently used setup.</li> <li>■ Open files. While in the Functions mode, only Setup files impact the Functions mode. You can open waveform and sequence file types, and the Waveform and Sequence lists will be populated, but these are only available for use when in the AWG mode.</li> <li>■ Save the current setup.</li> <li>■ Toggle the font size.</li> </ul>

## Front-panel connectors

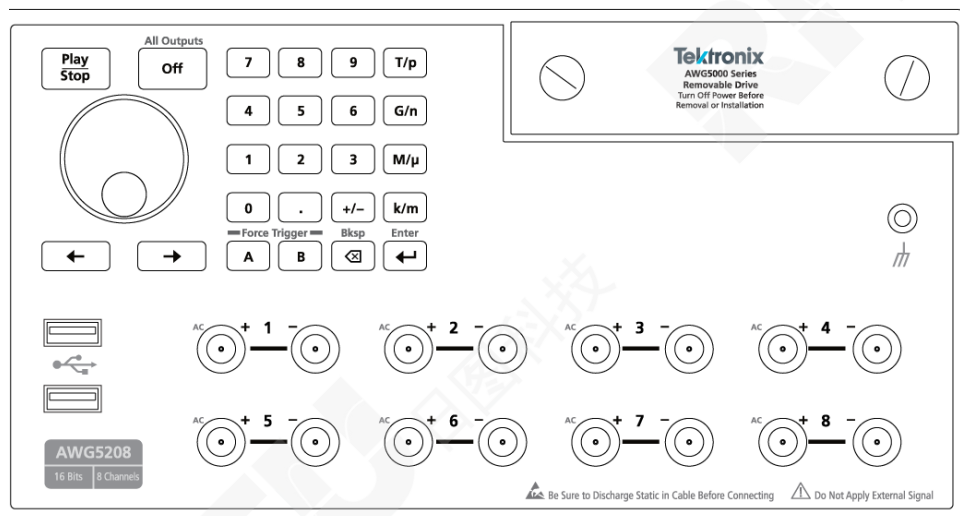

**Table 1: Front-panel connectors**

Connector	Description
Analog outputs (+ and -) AWG5202 – Two channels AWG5204 – Four channels AWG5208 – Eight channels	These SMA type connectors supply the complimentary (+) and (-) analog output signals.  The channel LEDs light to indicate when the channel is enabled and the output is electrically connected. The LED color matches the user defined waveform color.  The channel (+) and (-) connectors are electrically disconnected when the All Outputs Off control is activated.
AC outputs (+)	The (+) connector of each channel can supply a single-ended analog signal when an AC output mode is activated for the channel. The AC output provides for additional amplification and attenuation of the output signal.  The (-) connector of the channel is electrically disconnected. For best EMI reduction, install a 50 Ω termination to the (-) connector when using the AC output mode.
USB	Two USB2 connectors.
Removable hard disk drive (HDD)	The HDD contains the operating system, product software and all user data. By removing the HDD, user information such as setup files and waveform data is removed from the instrument.
Chassis ground	Banana type ground connection.



**CAUTION.** Always turn off the signal outputs when you connect or disconnect cables to/from the signal output connectors. Use the All Outputs Off button (either the front-panel button or the screen button) to quickly disable the Analog and Marker outputs. (Marker outputs are located on the rear panel.) When the All Outputs Off is enabled, the output connectors are electrically disconnected from the instrument.

Do not connect a DUT to the front-panel signal output connectors when the instrument signal outputs are on.

Do not power on or off the DUT when the generator signal outputs are on.

## Front-panel controls

The following illustration and table describe the front panel controls.

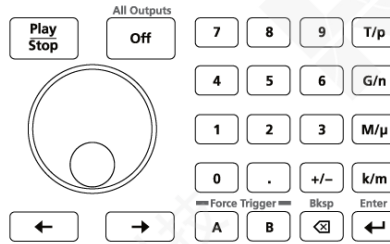

Buttons/Keys	Description
Play/Stop	<p>The Play/Stop button starts or stops playing the waveform.</p> <p>The Play/Stop button displays the following lights:</p> <ul style="list-style-type: none"> <li>No light - no waveform playing</li> <li>Green - playing a waveform</li> <li>Flashing green - preparing to play a waveform</li> <li>Amber - play out temporarily inhibited due to a settings change</li> <li>Red - Error preventing play out</li> </ul> <p>When a waveform is playing, it is only present at the output connectors if the following conditions are met:</p> <ul style="list-style-type: none"> <li>The channel is enabled.</li> <li>The All Outputs Off is not active (outputs are connected).</li> </ul>
General purpose knob	<p>The general purpose knob is used to increment or decrement values when a setting is enabled (selected) for change.</p> <p><b>NOTE.</b> The general purpose knob operation mimics the actions of the up and down arrow keys on a keyboard as defined by the Windows operating system. Because of this, rotating the knob when a desired control is not selected may result in seemingly odd behavior of the control or accidental changes to some other control.</p>
Numeric keypad	<p>The numeric keypad is used to directly enter a numeric value into a selected control setting.</p> <p>Units prefix buttons (T/p, G/n, M/μ, and k/m) are used to complete an input with the numeric keypad. You can complete your entry by pushing one of these prefix buttons (without pressing the Enter key).</p> <p>If you push the units prefix buttons for frequency, the units are interpreted as T (tera-), G (giga-), M (mega-), or k (kilo-). If you push the buttons for time or amplitude, the units are interpreted as p (pico-), n (nano-), μ (micro-), or m (milli-).</p>
Left and Right Arrow buttons	<p>Use the arrow buttons to change (select) the focus of the cursor in the Frequency control box when and IQ waveform is assigned to the channel. The Digital Up Converter (DIGUP) must be licensed to assign IQ waveforms to a channel..</p>

Buttons/Keys	Description
Force Trigger (A or B)	The A or B Force Trigger buttons generate a trigger event. This is only effective when the Run mode is set to Triggered or Triggered Continuous.
All Outputs Off	The All Outputs Off button provides a quick disconnect of the Analog, Marker, and Flag outputs, whether those outputs are enabled or not. (All Outputs Off overrides the channel output enable controls.)  When activated, the button lights, the outputs are electrically disconnected, and the channel output front-panel lights are turned off.  When the All Outputs Off is deactivated, the outputs return to their previously defined state.

## Rear-panel connectors

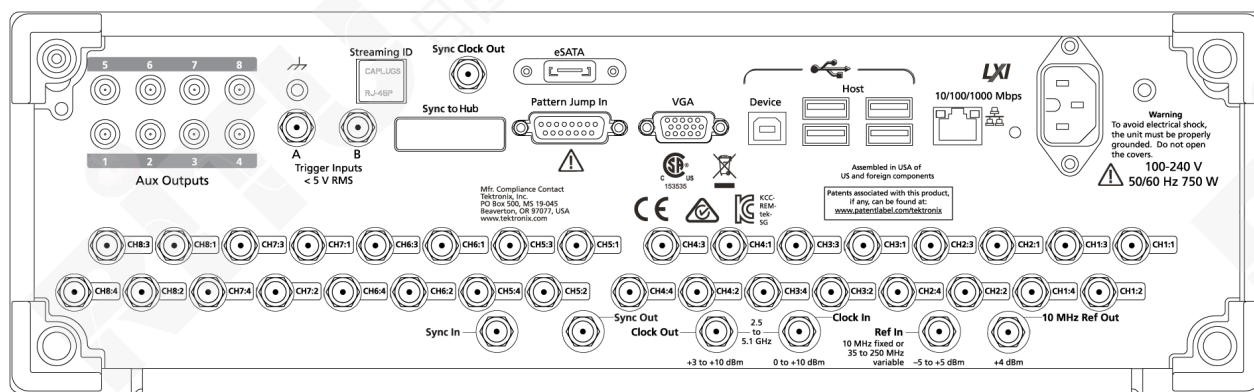

Table 2: Rear-panel connectors

Connector	Description
Aux Outputs AWG5202 - Four AWG5204 - Four AWG5208 - Eight	SMB connectors to supply output flags to mark the state of sequences.  These outputs are not affected by the All Outputs Off state.
Chassis ground	Banana type ground connection.
Trigger Inputs A and B	SMA type input connectors for external trigger signals.
Streaming ID	RJ-45 connector for future enhancement.
Sync Clock Out	SMA type output connector used to synchronize the outputs of multiple AWG5200 series generators.  This output is not affected by the All Outputs Off state.
Sync to Hub	Connector for future enhancement.
eSATA	eSATA port to connect external SATA devices to the instrument.
Pattern Jump In	15-pin DSUB connector to provide a pattern jump event for Sequencing. (Requires SEQ license.)
VGA	VGA video port to connect an external monitor to view a larger copy of the instrument display (duplicate) or to extend the desktop display. To connect a DVI monitor to the VGA connector, use a DVI-to-VGA adapter.
USB Device	USB Device connector (type B) interfaces with the TEK-USB-488 GPIB to USB adapter and provides connectivity with GPIB based control systems.

Connector	Description
USB Host	Four USB3 Host connectors (type A) to connect devices such as a mouse, keyboard, or other USB devices. Tektronix does not provide support or device drivers for USB devices other than the optional mouse and keyboard.
LAN	RJ-45 connector to connect the instrument to a network.
Power	Power cord input.
Marker outputs	SMA type output connectors for marker signals. Four per channel. These outputs are affected by the All Outputs Off state.
Sync In	SMA type connector to use a synchronization signal from another AWG5200 series instrument.
Sync Out	Connector for future enhancement.
Clock Out	SMA type connector to provide a high speed clock that is related to the sample rate. This output is not affected by the All Outputs Off state.
Clock In	SMA type connector to provide an external clock signal.
Ref In	SMA type input connector to provide a reference timing signal (variable or fixed).
10 MHz Ref Out	SMA type output connector to provide a 10 MHz reference timing signal. This output is not affected by the All Outputs Off state.

## Touchscreen interface

The arbitrary waveform generator offers a touchscreen interface that you can use to access all features and controls.

Enable or disable the touchscreen interface via the user Preferences on the Utilities tab.

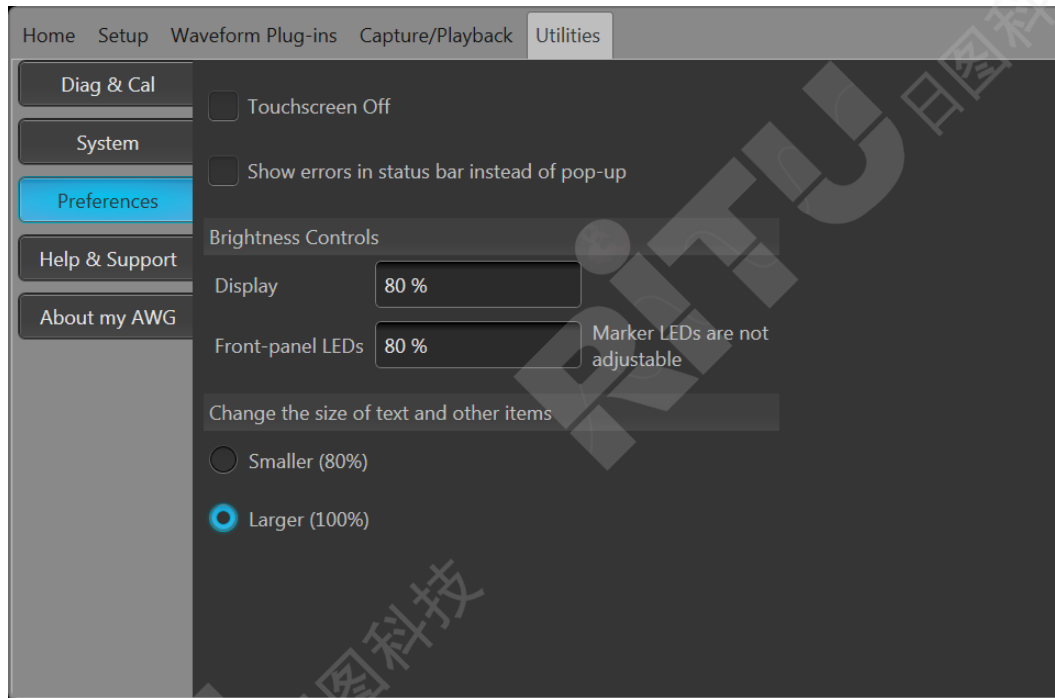

When the touchscreen is enabled, you can use your finger or a stylus to control all operations of the instrument from the display. The touchscreen can be used alone or in combination with a mouse and front-panel controls.



**NOTE.** The stylus must be of the conductive type designed for projected-capacitance screens, such as commonly used with smart phones and tablets.

When the touchscreen is disabled, on-screen menus are then operated via the front panel or an external keyboard and mouse.





**NOTE.** If the instrument is powered on in Windows Safe Mode, the touchscreen is inoperative. You may need to use a mouse or keyboard to restore normal operation.

## Run state control

Start and stop the waveform play out (run state) using the Play button. Start the waveform play out using the Play button, but no signal is output through the Analog Output connectors unless the Channel output is enabled.

### Run state status indicators (screen PlayStop button)

The play button in the graphical interface changes appearance to indicate the waveform play out status. Below are the various indicators.

Indicator	Description
	Not lighted – stopped (or idle) with no waveforms being played.
	Green with sine wave – currently playing a waveform.
	Green with T symbol – waiting for a trigger event to begin waveform play out.
	Yellow with clock symbol – the instrument is busy and play out is temporarily inhibited.
	Red – An error is preventing waveform play out.

### Run state status indicators (front-panel PlayStop button)

The front-panel play button  changes appearance to indicate the waveform play out status. Below are the various indicators.

Indicator	Description
Not lighted	Stopped (or idle) with no waveforms being played.
Green	Currently playing a waveform.
Flashing green	Waiting for a trigger event to begin waveform play out.
Amber	The instrument is busy and play out is temporarily inhibited.
Red	An error is preventing the waveform play out.

## Run mode

The AWG supports the following Run modes:

**Continuous.** Waveform play out starts when the Play button is pressed, without the need for a trigger event.

**Triggered.** Waveform play out starts when a proper external trigger event occurs or a Force Trig ( A or B) button is pressed. Waveform play out stops after one complete waveform cycle.

Waveform play out can not be retriggered until the current waveform play out completes an entire cycle. For two channel instruments, both waveforms must complete a cycle.

Pressing a **Force Trig ( A or B)** button has no effect if play out is in process.

**Triggered Continuous.** Waveform play out starts when a proper external trigger event occurs or a Force Trig (A or B) button is pressed. Once a trigger event occurs, waveform play out continues until stopped by the user.

## Changing control settings

As you configure the instrument, you might need to set a numerical parameter such as an amplitude level or offset. To set these parameters in a screen window, touch or click the parameter to select it. Once the parameter is selected, the general purpose knob is assigned to the parameter.

Use the general purpose knob to change parameters, although the following methods are generally available.

- Some parameters supply a pop-up keyboard that you can use to enter a new value.  
Touch or click the keyboard icon to display the keyboard.

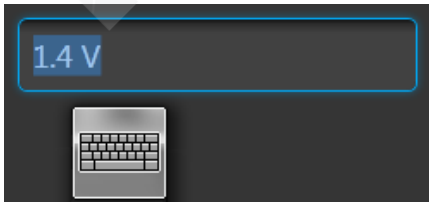

- Enter the desired value using the numeric keypad on the front panel or with an attached USB keyboard.

## Preferences

Use the Preferences to set certain instrument characteristics that are retained for each subsequent power on cycle.

In the toolbar, go to Utilities > Preferences to access user preferences.

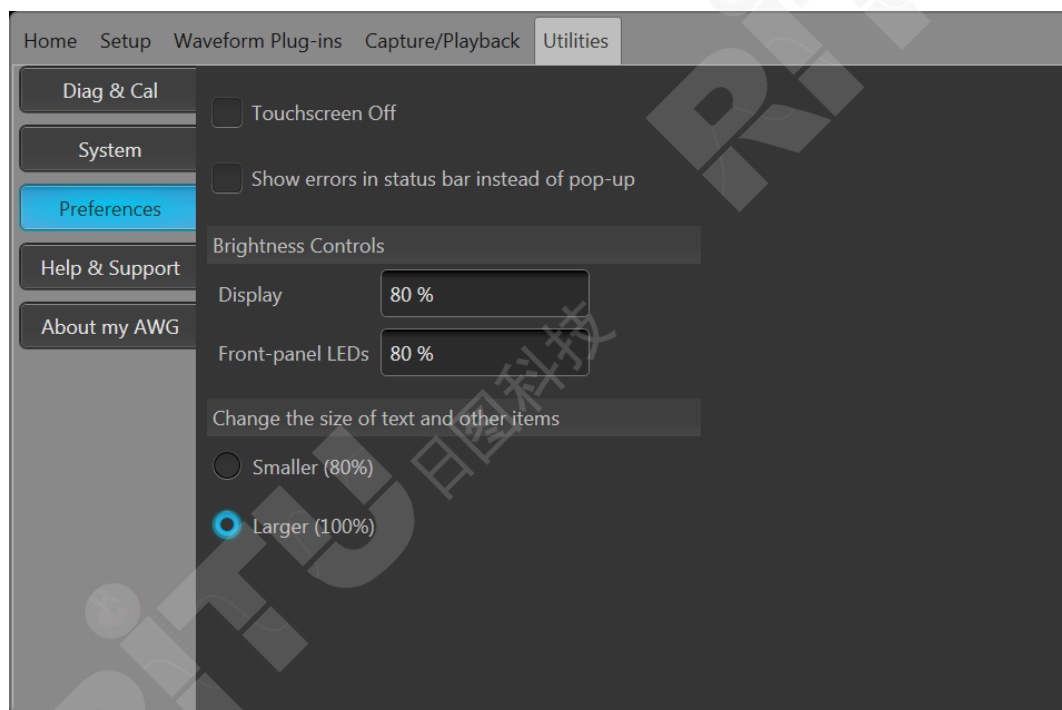

**Touchscreen control.** You can choose to disable the instrument's touchscreen.

**Error display control.** You can choose to disable all error pop-up screens. When enabled, errors messages are displayed in the status bar at the bottom of the display.

**Brightness controls.** Adjust the brightness levels of the display and front panel LEDs.

---

**NOTE.** Marker front panel LEDs are not adjustable.

---

**Display size control.** You can choose to reduce the display size of all text and dialog screens.

## System

Use the System to set certain instrument characteristics that are retained for each subsequent power on and to secure the instrument.

In the toolbar, go to Utilities > System.

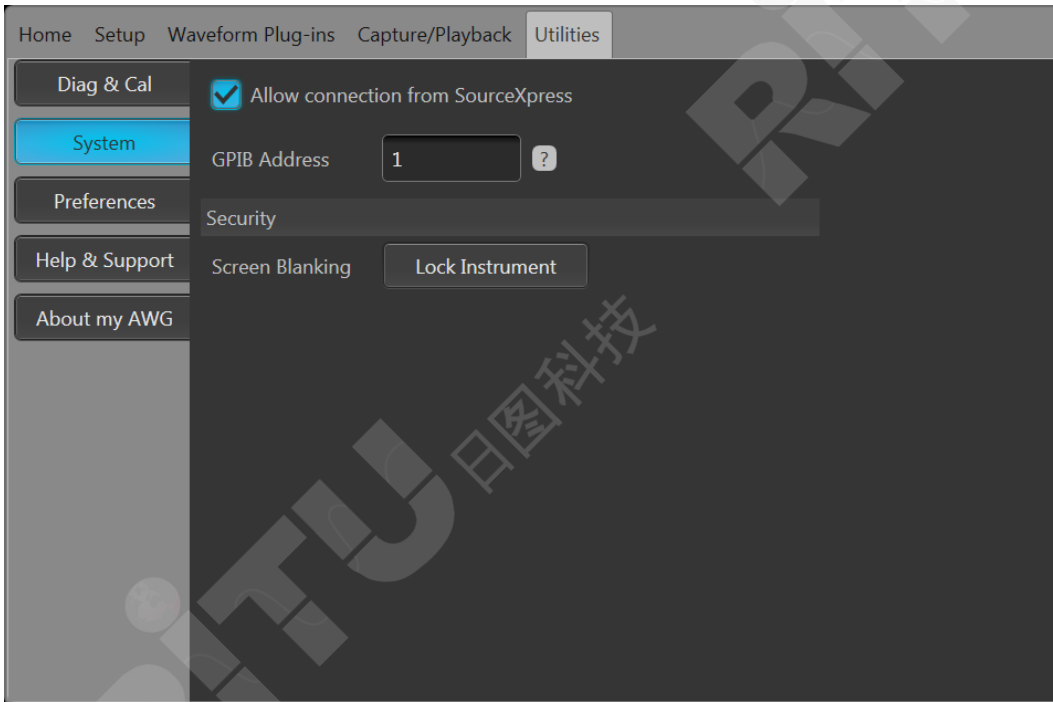

**SourceXpress connection.** You can choose to disable the ability of the external SourceXpress application to connect to the instrument. SourceXpress has the ability to connect to, and control, the instrument directly from its interface. This setting is retained for subsequent power on cycles.

**GPIB.** You can enter a unique GPIB address here. If changing the address, you must disconnect and reconnect the external USB-to-GPIB converter.

**Security.** Press the **Lock Instrument** button to lock the user interface screen and controls. When locked, all front-panel controls are disabled except for the power button.

## Basic guidelines to play a waveform

The Arbitrary Waveform Generator provides many controls and options that you can use when preparing to play a waveform.

Here are some basic guidelines and tips to help obtain your goal of playing a waveform. Refer to the instrument's help system for more detail about instrument controls and functions.

- Load a waveform (or waveforms) into the waveform list.
- Assign a waveform (from the waveform list) to a channel.
- Set the Run mode, see [Run mode](#) on page 26. If using a triggered run mode, supply the necessary trigger event.
- Enable the channel output.
- Make sure All Channels Off control is not active.
- Press the Play button (front-panel or screen).
- To deal with problems or errors, refer to the instrument help system.

---

# Restoring software

## Restoring instrument operating system and product software

The instrument software runs on the Windows Operating System (OS).

If needed, you can restore both the instrument's Windows OS and the AWG product software directly from the instrument.

- To restore the Windows OS and AWG product software to the original factory condition, see the Internal recovery utility procedure.
- To update only the AWG product software, see the AWG5200 Series product software upgrade procedure.

---

**NOTE.** Updating the AWG product software does not require that you restore the Windows OS.

The instrument does not ship with any external restore discs.

---

### Internal recovery utility

This is the preferred method to restore a damaged Windows Operating System. This method restores the Windows Operating System and the AWG product software using the Acronis Startup Recovery Manager. The Acronis software restores the instrument to its factory condition using restore images preinstalled on the hard drive.

---

**NOTE.** This utility reformats the hard disk drive during the restore process. The product software and all user data will be lost. (The Acronis Recovery partition and the related data are not destroyed.)

The restore images remain, providing the ability to repeat the recovery process.

The Windows operating system provided is designed for this instrument's hardware and product software.

---

1. Attach a keyboard to the instrument.
2. Restart the instrument. During the boot-up process you will see the following message at the top of the screen:  
Starting Acronis Loader... press F5 for Acronis Startup Recovery Manager
3. Repeatedly press the F5 key until the Acronis True Image Tool opens.

There is a 15-second time period from when the message appears until the instrument proceeds with the normal instrument startup. If the instrument does not open the Acronis application, power off the instrument, then power on the instrument and try again.

4. Within the Acronis TrueImage window, click Restore.
5. In the Confirmation dialog box, click Yes to begin the restore the process, or No to exit.

When finished, the AWG product software is the version shipped with your instrument. All upgrades or applications installed after your purchase will have to be reinstalled.

### **AWG5200 Series product software upgrade**

Follow this process to update the product software on your instrument.

1. Download the AWG5200 Series product software installation package available on the Tektronix web site. The installation package contains:
  - Instructions
  - AWG5200 Series product software installer package
2. Install the AWG5200 Series product software following all on-screen prompts.

Other applications or plug-ins can be similarly upgraded.

Tektronix recommends to always upgrade to the current version of product software available.

# Index

10 MHz Reference Output  
rear-panel, 24

## A

About my AWG, 13  
AC output  
front-panel connectors, 21  
Accessories, 3, 4  
All outputs off, 18, 20  
All Outputs Off button, 23  
Analog output  
front-panel connectors, 21  
Analog outputs  
front-panel connectors, 21  
LED color, 21  
Arrow buttons, 22  
Aux Outputs  
rear-panel, 23  
AWG mode overview, 17  
AWG mode selector, 18, 20

## B

Basic guidelines, 28  
Brightness, 27

## C

Calibration, 10  
Channel controls display  
On/Off, 19  
Channel enable, 18, 20  
Chassis ground  
front-panel connector, 21  
Cleaning, 7  
Clock Output  
rear-panel, 24  
Connectors  
rear-panel, 23  
Continuous  
Run mode, 26  
Control panel, 22  
Control settings

how to change, 26

## D

Diagnostics, 9  
Disable outputs, 18, 20  
Disconnect outputs, 18, 20  
Display properties, 15  
Display size, 27  
Documentation, 1

## E

Enable channel, 18, 20  
Environmental requirements, 7  
error indication, 25  
Error message display, 27  
eSATA port  
rear-panel, 23  
External Clock Input  
rear-panel, 24  
External monitor, 23  
External SATA, 23

## F

Flag Outputs  
rear-panel, 23  
Font size, 19, 20  
Force Trig, 26  
Force Trigger buttons, 23  
Forced shutdown, 9  
Front-panel  
connectors, 21  
Functions mode overview, 19  
Functions mode selector, 18, 20

## G

General purpose knob, 22  
GPIB address, 28

## H

- Hard drive
  - front-panel, 21
- Help button, 19, 20

## I

- Incoming inspection, 9
- Inspection, 9
- Install
  - options, 13
  - upgrades, 13

## L

- LAN connector
  - rear-panel, 24
- LED color
  - Analog outputs, 21
- Lock instrument, 28

## M

- Menu bar
  - Screen interface, 20
- Menu tabs
  - Screen interface, 18
- Mode selection
  - AWG, 18, 20
  - Functions, 18, 20

## N

- Network connection, 12
- Numeric keypad, 22

## O

- Open, 19
- Open setup, 19, 20
- Operating requirements, 6
- Operating system restore, 29
- Option
  - installation, 13
  - list, 13
- Output on/off, 25

- Outputs disabled, 18, 20
- Overheat protection, 12
- Overview
  - AWG mode, 17
  - Functions mode, 19

## P

- Pattern Jump In
  - rear-panel, 23
- Play a waveform, 18
- Play button, 18, 20
- Play/Stop button, 18, 20, 22
- Play/Stop button (screen)
  - green with sine wave, 25
  - green with T symbol, 25
  - no light, 25
  - red, 25
  - yellow with clock symbol, 25
- Play/Stop front-panel button
  - amber, 25
  - flashing green, 25
  - green, 25
  - no light, 25
  - red, 25
- Playing a waveform
  - guidelines, 28
- Pop-up keypad, 26
- POST
  - Power-on self test, 9
- Power button
  - flashing red, 8, 12
  - green, 8
  - indicators, 8
  - no light, 8
  - yellow, 8
- Power cord
  - rear-panel, 24
- Power cord input, 24
- Power supply requirements, 7
- Power-on self test
  - POST, 9
- Powering off, 9
- Powering on, 8
- Preferences, 26
- Product software installation, 29



## R

- Rear-panel
  - connectors, 23
- Recommended accessories, 4
- Reference Input
  - rear-panel, 24
- Remote desktop, 12
- Remote PC
  - Controlling the instrument, 12
- Removable hard drive, 21
- Replaceable parts, 6
- Requirements
  - environmental, 7
  - operating, 6
  - power supply, 7
- Restore
  - AWG product software, 29
  - Windows operating system, 29
- Restore Default Layout, 19, 20
- Restore default setup, 19, 20
- Restore last setup, 19, 20
- Run Mode
  - Continuous, 26
  - Triggered, 26
  - Triggered Continuous, 26
- Run state control, 25

## S

- Save, 19
- Save setup, 19, 20
- Screen interface, 18
- Security, 28
- Self calibration, 10
- Sequences, 18
- Setup
  - default, 19, 20
  - open, 20
  - save, 20
- Shutdown
  - forced, 9
- Software installation, 29
- SourceXpress connection, 28
- Standard accessories, 3

- Status bar
  - Screen interface, 20
- Status indicators (Play/Stop button), 25
- Status indicators (screen), 25
- Status message
  - calibration recommended, 10
- Stop button, 18, 20
- Streaming ID
  - rear-panel, 23
- Sync Clock Out
  - rear-panel, 23
- Sync Input
  - rear-panel, 24
- Sync Markers
  - rear-panel, 24
- Sync Output
  - rear-panel, 24
- Sync to Hub
  - rear-panel, 23
- System, 27

## T

- TekVISA installation, 29
- Tools panel, 19, 20
- Touch screen, 24
- Touchscreen control, 27
- Trigger controls
  - Screen interface, 18
- Trigger Inputs A and B
  - rear-panel, 23
- Triggered
  - Run mode, 26
- Triggered Continuous
  - Run mode, 26

## U

- Upgrade installation, 13
- USB connector
  - front-panel connector, 21
  - rear-panel, 24
- USB Device
  - rear-panel, 23

## V

VGA port

rear-panel, 23

Video port, 23

View installed licenses, 14

View installed options, 14

## W

Waveform

screen interface, 18

Waveform color, 21

Waveform plot display

On/Off, 19

Windows remote desktop, 12

Windows shutdown, 9



日图抖音号



日图公众号

### 深圳总部

深圳市南山区留仙大道南山云谷创新产业园二期 6 栋一楼东座  
电话：0755-83680722(8 线)

### 上海分公司

上海市闵行区中春路 8633 弄万科七宝国际 26 幢 701 室  
电话：021-3388891/3/5  
手机：13564654980

### 广州分公司

广州市科学城科学大道中 97 号科汇金谷 J 栋东座 808 室  
电话：020-31604020  
手机：18027340836

### 西安分公司

陕西省西安市雁塔区长安中路南飞鸿广场 3 号楼 1813 室  
手机：15529365365

### 杭州分公司

浙江省杭州市萧山区盈丰街道鸿宁路 1819 号左右世界 1 幢 1 单元 702-3  
电话：0571-86856181  
手机：18668225058

### 重庆分公司

重庆市观音桥茂业东方时代大厦 35 楼 3509 室  
电话：023-67904187  
手机：13896060852

### 苏州分公司

苏州苏州工业园区科营路 2 号中新生态大厦 10 楼 1010 室  
电话：0512-62515781、0512-62515784  
手机：15895400640

### 香港分公司

香港新界元朗屏厦村厦村路 DD125 段 1215-1217lot  
电话：+852-24932683

## 深圳市日图科技有限公司

SHENZHEN RITU SCIENCE TECHNOLOGY CO.,LTD

www.rituchina.com

400-616-5217

广东省深圳市南山区留仙大道南山云谷创新产业园二期 6 栋一楼东座

① 如需所有最新配套资料，请立即与日图科技各地分公司联系。