

NSG 4070C1 TEST SYSTEM FOR CONDUCTED AND RADIATED IMMUNITY



- **Integrated signal generator**
4 kHz to 1 GHz
- **3 power meter inputs**
4 kHz to 1 GHz
- **Integrated class A power amplifier module for different applications:**
35 W, 150 kHz to 230 MHz;
45 W, 9 kHz to 1 GHz;
60 W, 10 kHz to 400 MHz (>10 W at 4 kHz);
80 W, 150 kHz to 230 MHz;
110 W, 10 kHz to 400 MHz (>10 W at 4 kHz)
- **Multiple EUT monitoring options**
- **5.7" TFT color display**
- **Internal, menu-based control software**
- **Optically decoupled remote control**
- **Whisper mode**

Standards:

- IEC / EN 61000-4-3
- IEC / EN 61000-4-6
- IEC / EN 61000-4-20
- IEC / EN 61000-4-21
- IEC 62132
- ISO 11452-4
- MIL-STD-461 CS114
- And others

The NSG 4070 is a multi-functional device for carrying out EMC immunity tests to accompany development and conformity testing in accordance to IEC/EN 61000-4-6, Namur and several automotive BCI standards. Anyone who spends a considerable amount of time on test level setting, connecting EUT monitoring or writing test reports can now carry out immunity testing in a much more efficient manner with the 5th generation of NSG 4070.

Its modular set-up using internal or external amplifiers enables a large variety of applications. The powerful and easy to use firmware makes the NSG 4070 independent from an external PC and control software, however it can also be remote controlled for system operation. A state-of-the-art data transfer of test and measurement data for documentation is provided by USB stick to be plugged into the front panel.

Model range and applications

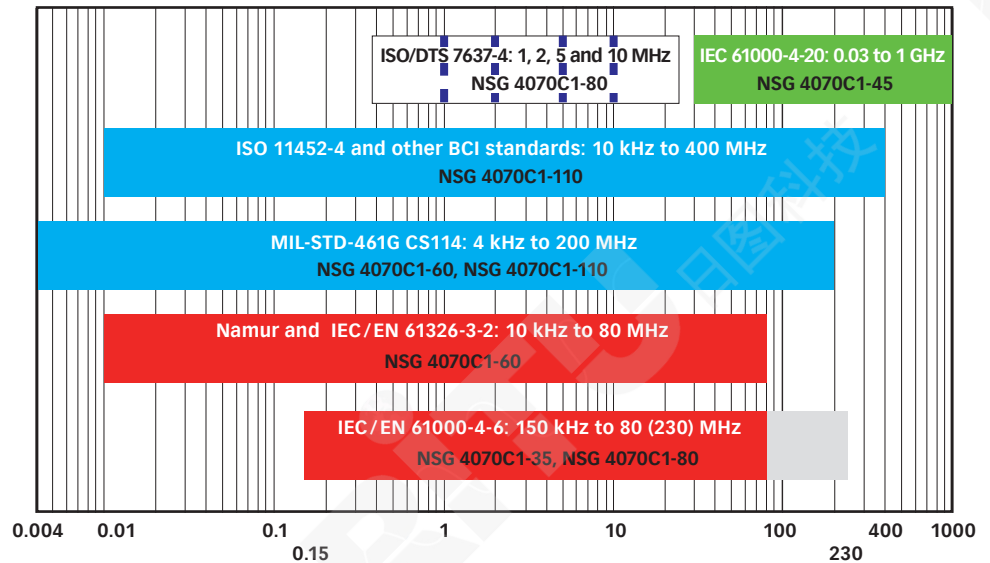

Frequency in MHz

- Induced RF - test levels in Volts , ■ Extended range by some product standards
- Bulk Current Injection (BCI) - test levels in mA or dBµA,
- Pulsed sinusoidal disturbances. - test levels in Vpp,
- Radiated fields - test levels in V/m

Note: Regardless of the built-in amplifier module, each NSG 4070 can be combined with an external power amplifier and directional coupler to provide maximum flexibility in the EMC laboratory. Of course, other NSG 4070 models than those shown here in the overview can also be used, as shown in the table on the next page.

NSG 4070C1 TEST SYSTEM FOR CONDUCTED AND RADIATED IMMUNITY

Selection guide for the power amplifier

Product	Power amplifier nominal power	Power amplifier frequency range	Immunity testing IEC/EN 61000-4-6) ¹ 150 kHz to 230 MHz			Immunity testing Namur) ¹ 10 kHz to 80 MHz			Automotive BCI testing) ² ISO 11452-4: 2011		Automotive BCI testing Ford FMC1278) ²		MIL-STD-461G CS114) ²	RTCA DO-160G CS Test) ²
			CDN	EM clamp	Current injection probe	CDN	EM clamp	Current injection probe	Substitution	Closed loop with k = 4	Substitution	Closed loop with k = 4	Substitution	Closed loop with k = 4
NSG 4070C1-0	-	-	*	*	*	*	*	*	*	*	*	*	*	*
NSG 4070C1-0 + external amp	260 W (>10W at 4 kHz)	10 kHz (4 kHz) to 400 MHz	30 V	30 V	15 V	30 V	11 V	3 V	600 mA > Level IV	300 mA > Level IV	115 dBµA Level 2	109 dBµA Level 2	114 dBµA Level 5	300 mA Level: M, Q, R, S, T, W, Y
NSG 4070C1-110) ³	110 W (>10W at 4 kHz)	10 kHz (4 kHz) to 400 MHz	30 V	26 V	10 V	30 V	7 V	2 V	400 mA > Level IV	200 mA > Level IV	112 dBµA Level 2	106 dBµA Level 2	114 dBµA Level 5	200 mA Level: M, R, S, T, W
NSG 4070C1-80	80 W	150 kHz to 230 MHz	30 V	22 V	8 V	*	*	*	*	*	*	*	*	*
NSG 4070C1-60) ³	60 W (>10W at 4 kHz)	10 kHz (4 kHz) to 400 MHz	27 V	19 V	7 V	27 V	5 V	1 V	300 mA > Level IV	150 mA Level III	109 dBµA Level 2	103 dBµA Level 1	109 dBµA Level 5	150 mA Level: M, R, S, T, W
NSG 4070C1-45	45 W	9 kHz to 1 GHz	24 V	17 V	6 V	24 V	5 V	1 V	260 mA > Level IV	130 mA Level III	108 dBµA Level 2	102 dBµA Level 1	108 dBµA Level 5	130 mA Level: M, R, S, T
NSG 4070C1-35	35 W	150 kHz to 230 MHz	21 V	15 V	5 V	*	*	*	*	*	*	*	*	*

All level calculated in relation to the standard requirements with typical values of the coupling device.

¹⁾ Calculated with 6 dB attenuator and AM with 80% modulation depth.

²⁾ Calculated with highest test level in the frequency range and related typical insertion loss of the BCI probe Teseq CIP 9136A.

³⁾ NSG 4070C1-60 and NSG 4070C1-110 measure the reverse power also with selected internal power amplifier (5 channel power meter and bidirectional coupler) as may required by the BCI standard.

*) Requires external directional coupler and external power amplifier for the frequency range and test level.

NSG 4070C1 TEST SYSTEM FOR CONDUCTED AND RADIATED IMMUNITY

Front panel

- External access to signal generator output and power amplifier input and output
- 3 power meter inputs
- 5.7" color display, easy to use firmware
- Hard keys for important functions

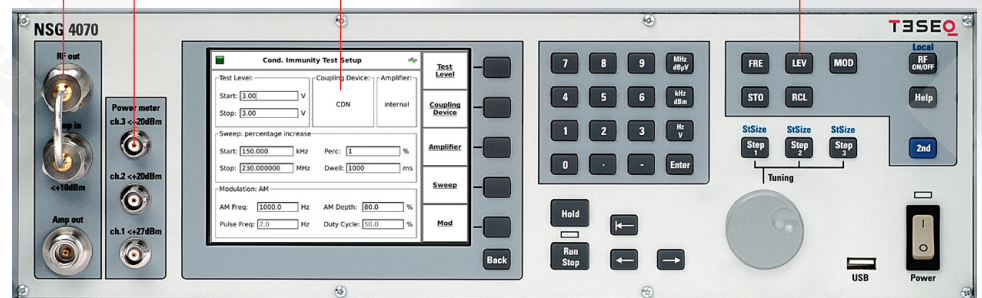

Back panel

- User port for 4 TTL inputs and 4 TTL outputs and supply voltages for individual monitoring and control applications
- Analog, digital and optical monitoring inputs for extensive EUT monitoring options
- Remote control via optical RS232, RS232, LAN or USB
- 2x USB, 10 MHz reference output, Trigger input, external modulation input

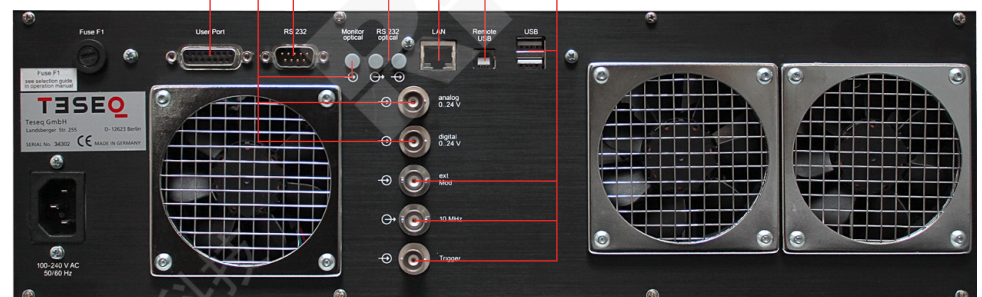

TESEQ

Advanced Test Solutions for EMC

NSG 4070C1 TEST SYSTEM FOR CONDUCTED AND RADIATED IMMUNITY

Block diagram of NSG 4070

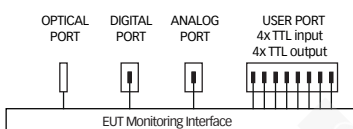
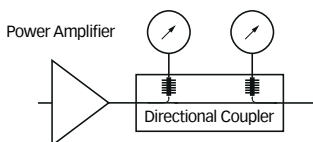
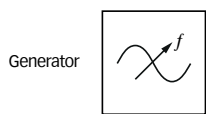
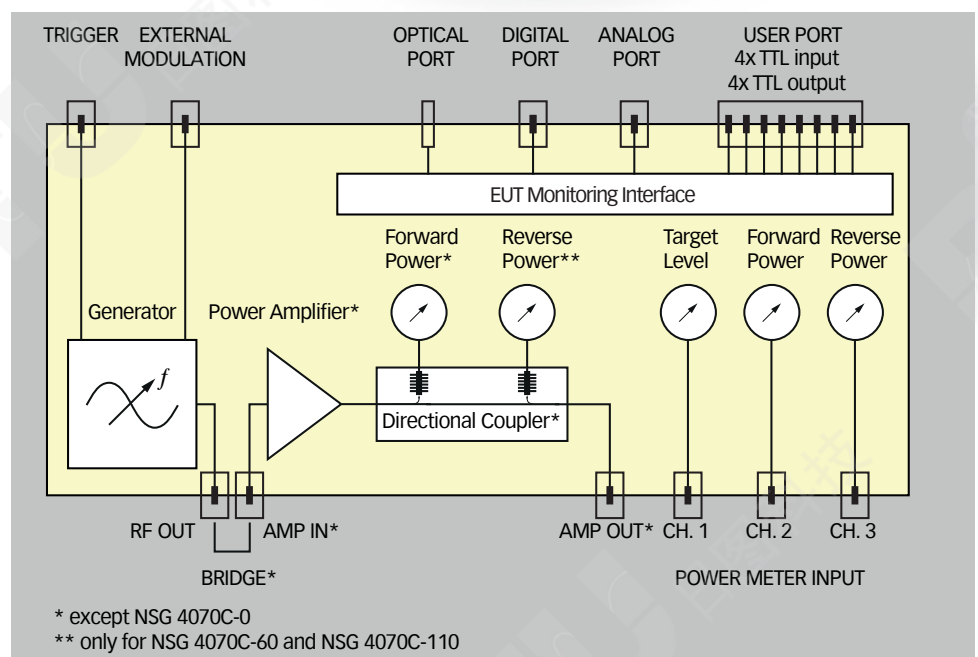

The heart of the device is the signal generator, which generates the sinusoidal signal over the wide frequency range from 4 kHz to 1 GHz and in the level range -60 dBm to +10 dBm. The built-in modulator allows amplitude and pulse modulation. The NSG 4070C1 contains extended parameters for pulse modulation and allows up to three envelopes to be interleaved. One input allows modulation from an external source.

The output of the signal generator is connected to the internal power amplifier via a bridge. Next to the amplifier a directional coupler is connected to measure the forward power. The NSG 4070C1-60 and NSG 4070C1-110 additionally measure the reverse power at the internal directional coupler. All NSG 4070 devices can measure forward and reverse power via an external directional coupler. For this application, power meter inputs 2 and 3 are located on the front panel. The power meter input 1 is intended for adjusting the target value and for connecting the current probe.

The EUT monitoring interface allows the simple and fast integration of the interfaces of the EUT to be monitored. The TTL inputs and outputs of the NSG 4070 can be used to integrate additional equipment for monitoring test specimens. The optical EUT monitoring input can detect the status of an indicator lamp. When using the extensive EUT monitoring functions, the user receives a meaningful test result with assignment of the events to the respective test frequency. Subsequent design changes to the EUT can thus be qualified more quickly.

NSG 4070C1 TEST SYSTEM FOR CONDUCTED AND RADIATED IMMUNITY

Firmware: Immunity mode

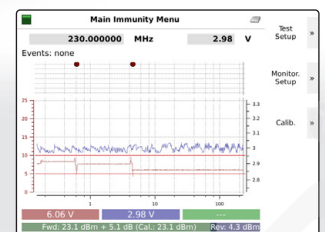
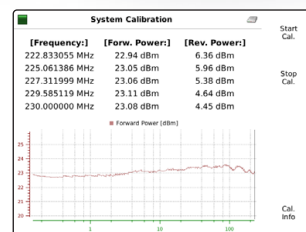
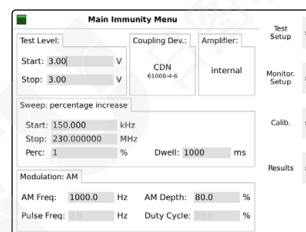

Configuration

Calibration

Testing



During the EMC tests, the test object undergoes different tests at different test stations. Among other things, short set-up times are an advantage so that the operating personnel can efficiently test the EUT. Switching on and testing expresses the wish of many users. With its unique menu-driven operation, the NSG 4070 fulfils this wish to operate tests according to IEC 61000-4-6 and simple automotive BCI tests from the front panel of the device. On-site testing of machines and systems is possible with the NSG 4070. The NSG 4070 contains configurations that the operator can load or modify according to the test being performed. This allows the parameter setting to be carried out with a user activity and in the shortest possible time. To execute a test, an existing system calibration file would have to be loaded or generated. Thanks to the very fast power meters and firmware optimized for fast measurement, the NSG 4070 takes less than a minute to calibrate for IEC 61000-4-6 with one-percent increments. During the test, the display changes to show the current frequency, level, EUT monitoring channels and their states. The response to EUT monitoring events can be adjusted. Irrespective of the EUT monitoring, the sweep can be interrupted with the "HOLD" key to manually change the frequency and level, for example, to further investigate the reaction of the DUT. Test results can be saved and reloaded as required. Based on a loaded test, tests can be repeated easily as the test configuration and system calibration data are included. When the test result is saved on a USB stick, a simple test report in PDF format and CSV format is also saved.

Firmware: Generator and Power Meter mode

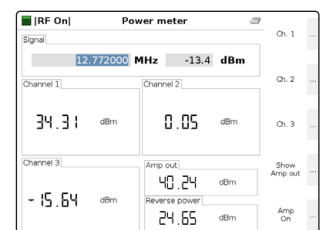
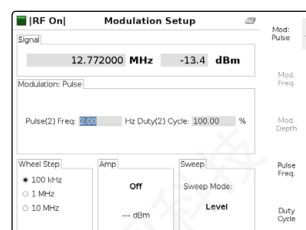

In addition to the Immunity menu for performing the EMC test, the NSG 4070, with two further menus, offers the option of operating the device as a stand-alone signal generator. The measured values of the power meters are displayed in the power meter menu. The operator can easily check his system and measure cables and attenuators.

NSG 4070C1 TEST SYSTEM FOR CONDUCTED AND RADIATED IMMUNITY

Optional Windows software icd.control

Pre-programmed Standard Test routines for fast and reliable testing

icd.control offers numerous Standard Test routines for various applications. With only a few steps a test is set up. Using Standard Test routines allows fast and reliable testing. The Standard Test routines can be modified and saved as user specific test routines in order to adopt special requirements, which go beyond the basic request without having to program such test routines from scratch. User specific test routines are composed easy, fast and efficient.

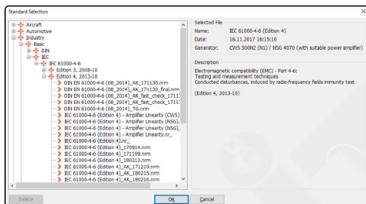

User Test routines - Programmed in vectors

Some test requirements may be too complex to be programmed in the common way. For such needs icd.control offers the vector programming mode. A test sequence can be specified with different vectors, each consisting of a start frequency/level and a stop frequency/level set of parameters. Even most complex requirements are easily set up and tested in the Vector mode.

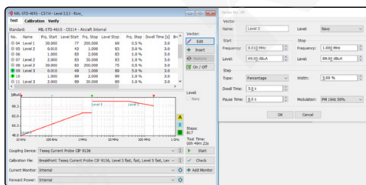

Implementation of external measuring instruments

External measuring equipment, e.g. Power Meter, Oscilloscope, Spectrum Analyser) can easily be implemented in the set-up for either measuring the injected RF test signal or for EUT monitoring during test. The data logger can handle almost every kind of measuring equipment having a GPIB interface. Up to four single channel instruments or any corresponding number of multi-channel equipment can be logged, each channel being individually controlled. Feedback signals from external instruments can be used as interrupts to control the test procedure.

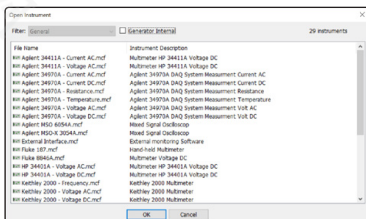

Enhanced reporting capability

icd.control offers an enhanced reporting capability. The complete test data including any comments entered in case of fail events is given in details. Graphics and data of the levelling, impedance characteristic and the recorded data from the used external measuring equipment can be included. Graphic information about the test set-up can be added for better documentation of the performed test. Test reports are automatically transferred into Rich-Text-Format (rtf) and can thus be easily post-processed by any software recognizing rtf format (e.g. Microsoft Word).

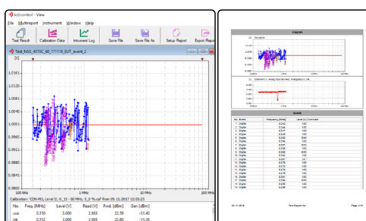

NSG 4070C1

TEST SYSTEM FOR CONDUCTED AND RADIATED IMMUNITY

Technical specifications

Generator

RF	
Frequency range:	4 kHz to 1 GHz
Resolution:	1 Hz
Reference frequency:	10 MHz
Aging:	25 ppm
RF Level	
Level range:	-60 dBm to +10 dBm
Resolution:	0.1 dB
Settling time:	10 ms
Amplitude modulation	
Modulation depth:	0 to 100%
Modulation frequency range:	1 Hz to 50 kHz
Frequency resolution:	1 Hz
Pulse modulation (possible to interlace up to three pulse modulations)	
Rise/fall time (10%/90%):	< 1 μ s
Modulation frequency range:	0.01 Hz to 1 MHz
Frequency resolution:	0.01 Hz
Duty cycle:	0.1% to 100%
External modulation	
Delay time:	< 1 μ s / 180°
Period:	min. 20 μ s
Pulse width:	min. 10 μ s

Power meter

Frequency range:	4 kHz to 1 GHz
Linear measurement range	
channel 1:	-35 dBm to +27 dBm (NSG 4070C1-60 and NSG 4070C1-110: -40 dBm to +27 dBm)
channel 2,3:	-45 dBm to +20 dBm
Max. input/no damage	
channel 1-3:	+28 dBm
Noise level:	>5 dB below the measurement range
Input return loss:	>20 dB (below 500 MHz), >17 dB (500 MHz to 1 GHz)
Connector:	BNC socket, 50 Ω
Accuracy 10 to 30°C:	<0.5 dB, typ. <0.3 dB

NSG 4070C1 TEST SYSTEM FOR CONDUCTED AND RADIATED IMMUNITY

Power amplifier

Nominal output power:	35 W	45 W	60 W	80 W	110 W			
Frequency range:	150 kHz to 230 MHz	9 kHz to 1 GHz	10 kHz (4 kHz) to 400 MHz	150 kHz to 230 MHz	10 kHz (4 kHz) to 400 MHz			
Type:	single band, class A	single band, class A	single band, class A	single band, class A	single band, class A			
Input/output impedance (nominal):	50 Ω	50 Ω	50 Ω	50 Ω	50 Ω			
Input return loss (minimum):	10 dB	10 dB	10 dB	10 dB	10 dB			
Output return loss without damage:	0 dB	0 dB	0 dB	0 dB	0 dB			
Gain (minimum):	48 dB	49 dB	4 kHz to 10 kHz 45 dB	10 kHz to 400 MHz 50 dB	50 dB	4 kHz to 10 kHz 47 dB	10 kHz to 400 MHz 50 dB	
Gain flatness (maximum):	+/- 3 dB	+/- 3 dB	+/- 3 dB	+/- 3 dB	+/- 3 dB			
Saturated output power (minimum):	44.9 dBm	< 400 MHz 46.0 dBm	> 400 MHz 44.3 dBm	4 kHz to 10 kHz 42 dBm	10 kHz to 400 MHz 48.5 dBm	48.5 dBm	4 kHz to 10 kHz 43 dBm	10 kHz to 400 MHz 49.9 dBm
Linear output power (minimum):	43.5 dBm	< 400 MHz 44.9 dBm	> 400 MHz 41.9 dBm	4 kHz to 10 kHz 40 dBm	10 kHz to 400 MHz 47.5 dBm	47.5 dBm	4 kHz to 10 kHz 41 dBm	10 kHz to 400 MHz 48.5 dBm
Input power without damage (maximum):	+10 dBm	+10 dBm	+10 dBm	+10 dBm	+10 dBm	+10 dBm	+10 dBm	+10 dBm
Harmonic distortion at linear output power (typical):	< -17 dBc	< -20 dBc	< -18 dBc	< -18 dBc	< -20 dBc	< -20 dBc	< -20 dBc	< -20 dBc

NSG 4070C1 TEST SYSTEM FOR CONDUCTED AND RADIATED IMMUNITY

Power amplifier of NSG 4070C1-35

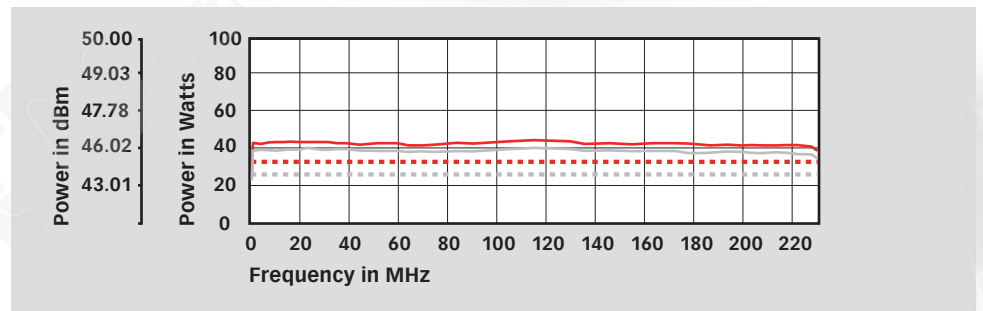

Power amplifier of NSG 4070C1-45

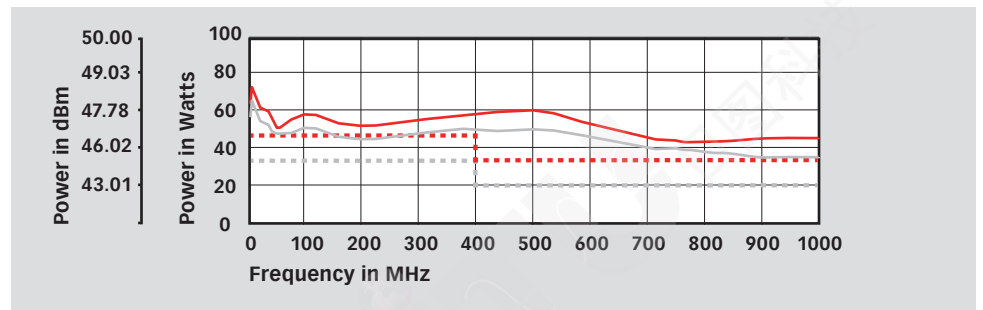

Power amplifier of NSG 4070C1-60

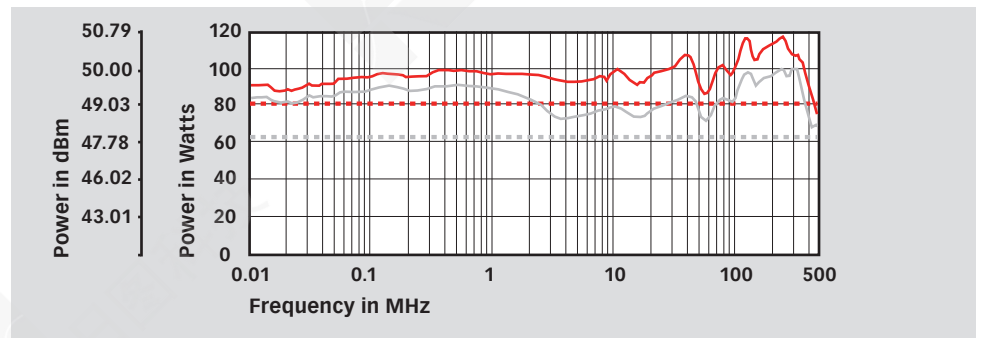

Legend

- typical saturated power
- typical linear power
- - - specification saturated power
- - - specification linear power

NSG 4070C1 TEST SYSTEM FOR CONDUCTED AND RADIATED IMMUNITY

Power amplifier of NSG 4070C1-80

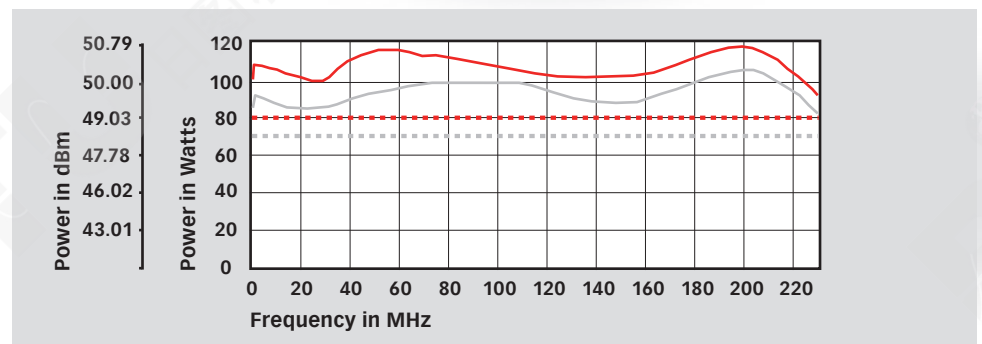

Power amplifier of NSG 4070C1-110

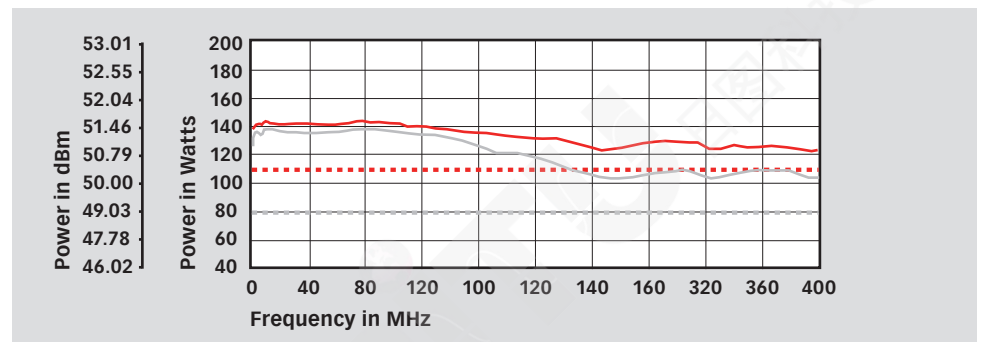

Legend

- typical saturated power
- typical linear power
- specification saturated power
- specification linear power

NSG 4070C1

TEST SYSTEM FOR CONDUCTED AND RADIATED IMMUNITY

Test and measurement routines

Firmware: Generator mode

Sweep:	Frequency sweep, level sweep
Modulation:	AM, AM PC (peak conservation), pulse modulation and external
Others:	Free parameter setting from 9 kHz to 1 GHz, high power mode using power amplifier

Firmware: Immunity mode

Level:	start and stop level or sections can be defined, max test levels depending on power amplifier or for IEC 61000-4-6 limited to 30 V EMF, for BCI tests levels in units mA or dB μ A
Test methods IEC 61000-4-6:	CDN, EM clamp, current clamp and direct injection, clamp injection with test level control using monitoring probe
Test methods BCI:	substitution method with optional use of the monitoring probe, closed loop method with power limitation (factor adjustable)
Sweep:	frequency or section sweep with linear, steps per decade or percentage increase
Modulation:	AM, AM PC (peak conservation), pulse modulation, external or mixed (e.g. 1 kHz AM internal modulated with 1 Hz PM external)
EUT monitoring:	Individual configuration of the port's functionality, display of events during the test, in the result file and in the test report
Calibration:	Test set-up and monitoring probe calibration, display, store and recall function of calibration files (limitation of file numbers only by the disk space, typical >340 files)
EUT threshold search:	Manual search by changing frequency or stress level
Store and recall:	Store and recall function of test configurations, calibration results and test results (number of files is only limited by the disk space, typical >340 files), supports USB sticks
Component check:	Quick check of system components, e.g. cable, attenuator max. 52 dB/54 dB/58 dB attenuation for 35 W/45 W/80 W amplifier, max. +16 dB gain at 27 dBm output level
Amplifier saturation check:	Validation that the power amplifier is not in saturation for the selected test level including 80% AM, see IEC 61000-4-6 Ed. 4 for more information (only available for firmware operation)
Additional features:	Free parameter setting from 9 kHz to 1 GHz, supports external power amplifier, RF switch SW 4070, monitoring probe MD 4070, directional coupler and attenuator

NSG 4070C1 TEST SYSTEM FOR CONDUCTED AND RADIATED IMMUNITY



NSG 4070 front panel with RF ports

Analog ports

Front panel	
Generator output:	N socket 50 Ω , 4 kHz to 1 GHz
Power amplifier input:	N socket 50 Ω , max. +10 dBm
Power amplifier output:	N socket 50 Ω
Power meter channel 1 to 3:	as defined in chapter "Power meter"
Back panel	
Monitoring input analog:	BNC socket, 0 to 24 V Ri=15 k Ω , 6 mV resolution
External modulation input:	BNC socket, impedance >10 k Ω , level: 1 Vpp to get 100% AM, 1 Hz to 50 kHz
10 MHz reference output:	BNC socket, approx. 1 Vpp/50 Ω

Digital ports

Front panel	
USB:	USB host connector for USB stick, keyboard, mouse
Back panel	
User port:	D-Sub 15 pole 4 TTL inputs 4 TTL outputs +12 V / 800 mA, -12 V / 200 mA, +5 V / 800 mA power supply
Monitoring digital input:	BNC socket 0 to 24 V via optical coupler Ri=1.5 k Ω , switching threshold approx. 2 to 3 V
Monitoring optical input:	LWL (Light wave connector), HP versatile link HFBR0501 series 40 kBd, (avoid scattered light on the back panel)
Trigger input:	BNC socket, TTL for external triggering, max. frequency 100 Hz, trigger delay <10 ms
RS232:	D-Sub 9 pole, up to 115200 Bd
RS232 optical:	Connector 2 x HFBRx523 socket for 1 mm fiber optic cable with length between 5 m and 30 m with 115200 Bd, for other distances 38400 Bd, max. 50 m
2x USB:	USB host connector for USB stick, keyboard, mouse
USB device connector:	For remote control
Network:	RJ45, Ethernet 10/ 100 BASE-T

NSG 4070C1

TEST SYSTEM FOR CONDUCTED AND RADIATED IMMUNITY

Power supply

Power consumption	100 to 240 VAC 50/60 HZ autoranging	Recommended fuse F1 for nominal 110 V	Recommended fuse F1 for nominal 230 V
NSG 4070C1-0	approx. 80 W	1 A (slow)	0.5 A (slow)
NSG 4070C1-35, -45, -60 and -80	approx. 415 W	6.3 A (slow)	2.5 A (slow)
NSG 4070C1-110 Generator: Power amplifier:	approx. 80 W <1 kW	1 A (slow) 10 A (slow)	0.5 A (slow) 10 A (slow)

General data

Operating temperature range:	0 °C to 40 °C
Storage temperature range:	-20 °C to 60 °C
Relative humidity:	95 % / 30 °C (no moisture condensation)
EMC:	DIN/EN 61326-1:2006
Shock:	DIN/EN 60068-2-27
Vibration:	DIN/EN 60068-2-6
Protection class:	DIN/EN 61010-1/IEC 61010-1

Mechanical specifications (except NSG 4070C1-110)

Size (W x H x D):	45 cm (19") x 15 cm (3HU) x 42.3 cm (with handle bar and foot)
Weight:	approx. 15 kg (with internal power amplifier), approx. 8 kg (without internal power amplifier)
Size of cardboard box:	80 cm x 61 cm x 34 cm (also for options ATN 60xx and/or LE 4070 additional space available)
Weight of cardboard box:	approx. 8 kg (empty)

Mechanical specifications (NSG 4070C1-110)

Size (W x H x D):	65 cm x 46 cm x 60 cm
Weight:	approx. 44 kg

NSG 4070C1 TEST SYSTEM FOR CONDUCTED AND RADIATED IMMUNITY

Application for IEC/EN 61000-4-6, calibration set-up with CDN

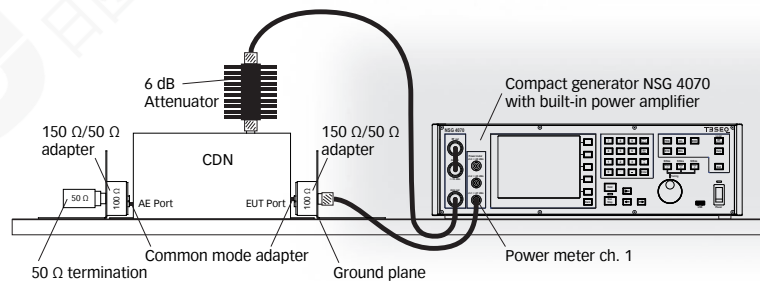

Application for IEC/EN 61000-4-6, EUT set-up with CDN

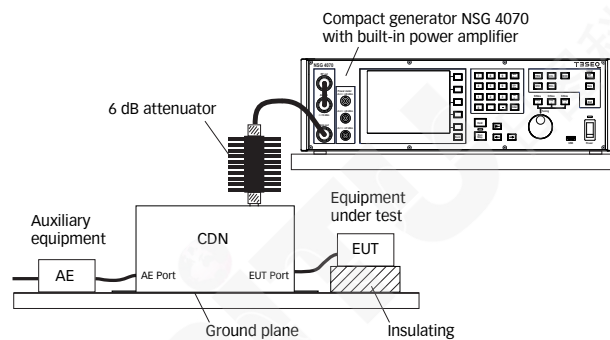

Application for IEC/EN 61000-4-6, calibration set-up with EM clamp

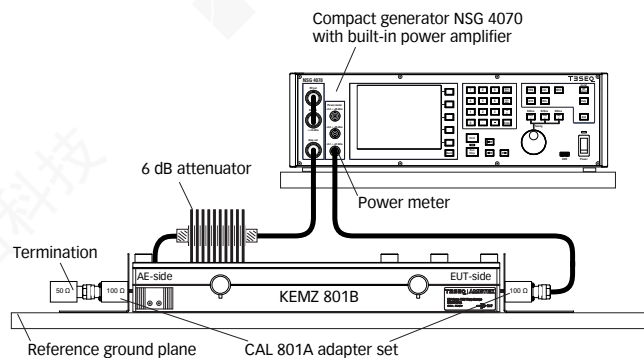

NSG 4070C1 TEST SYSTEM FOR CONDUCTED AND RADIATED IMMUNITY



LE 4070, RF cable set for NSG 4070, consist of:

- RF cable, N(m)-N(m), 3 m with one right-angle plug, RG223;
- RF cable, N(m)-BNC(m), 2 m, RG223;
- RF cable, BNC(m)-N(m), 250 mm;
- RF cable, N(m)-N(m), 120 mm;
- Adapter N(m)-N(m);
- Adapter N(f)-BNC(m)

Application for IEC/EN 61000-4-6, calibration set-up with current injection probe

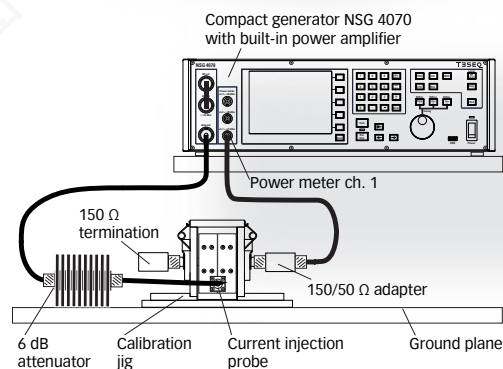

Application for IEC/EN 61000-4-6, EUT set-up with EM clamp or current injection probe and for example with use of a monitoring probe

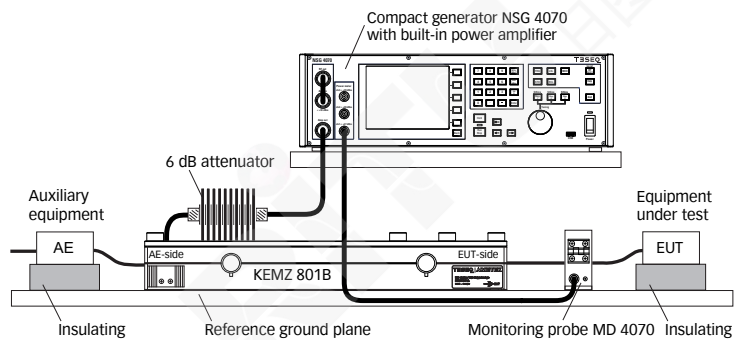

NSG 4070C1 TEST SYSTEM FOR CONDUCTED AND RADIATED IMMUNITY



NSG 4070C1-110

Application for automotive BCI, calibration set-up (example with NSG 4070C1-110)

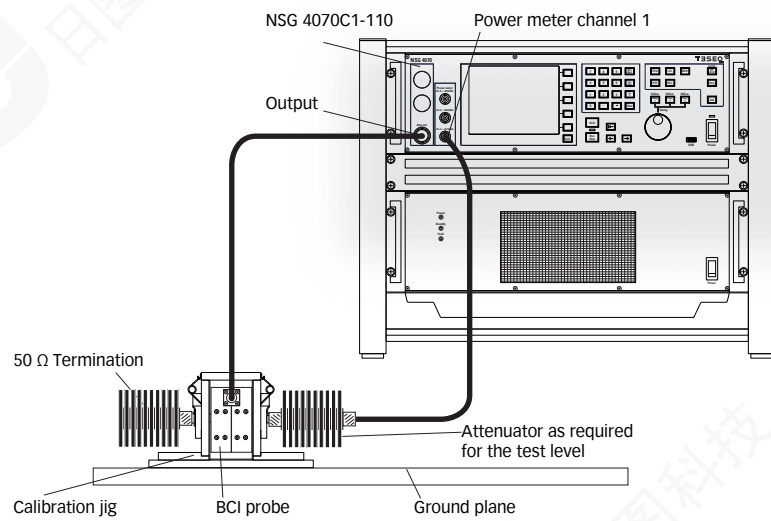

Application for automotive BCI, EUT set-up with monitoring probe and LISN (example with NSG 4070C1-110)

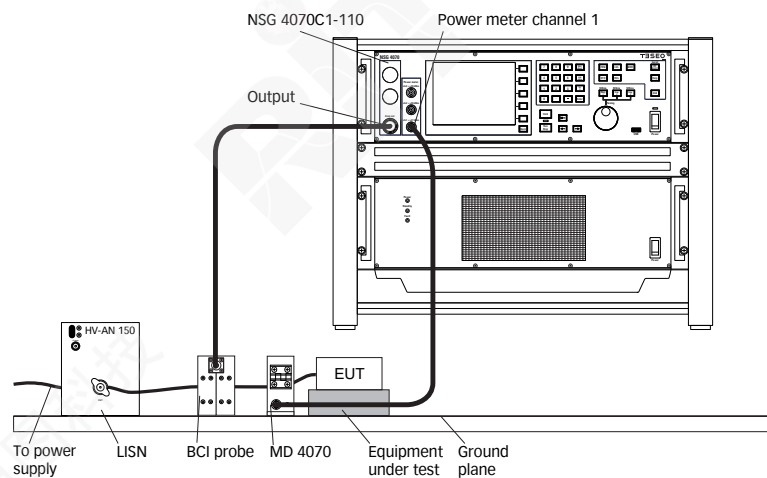

NSG 4070C1 TEST SYSTEM FOR CONDUCTED AND RADIATED IMMUNITY



NSG 4070-0 combined with RF switch network and power amplifiers for a complex solution up to 1 GHz

Application for automotive BCI, calibration set-up (example with external power amplifier and directional coupler)

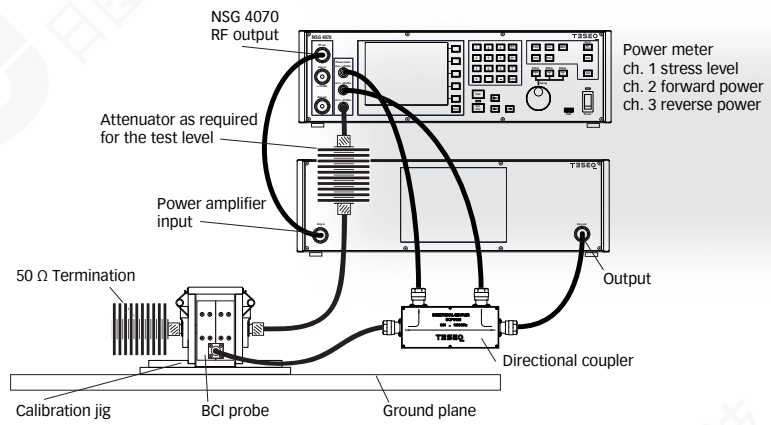

Application for automotive BCI, EUT set-up with monitoring probe (example with external power amplifier and directional coupler)

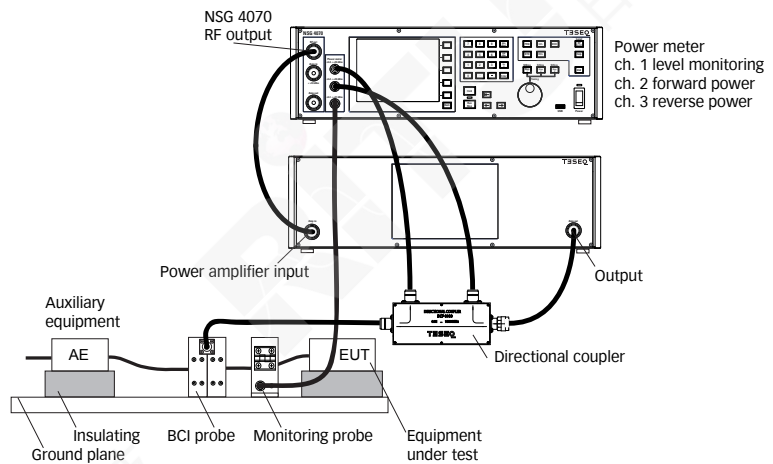

NSG 4070C1 TEST SYSTEM FOR CONDUCTED AND RADIATED IMMUNITY

Application for automotive BCI, calibration set-up (example with NSG 4070C1-60)

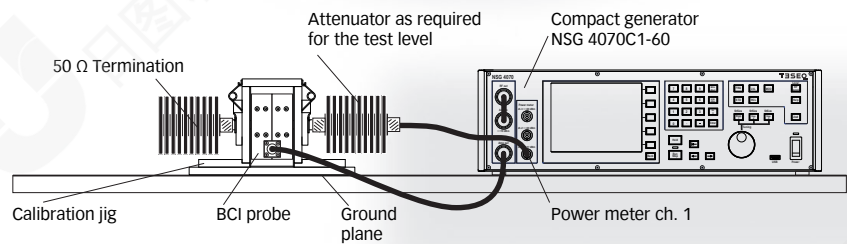

Application for automotive BCI, EUT set-up with monitoring probe and LISN (example with NSG 4070C1-60)

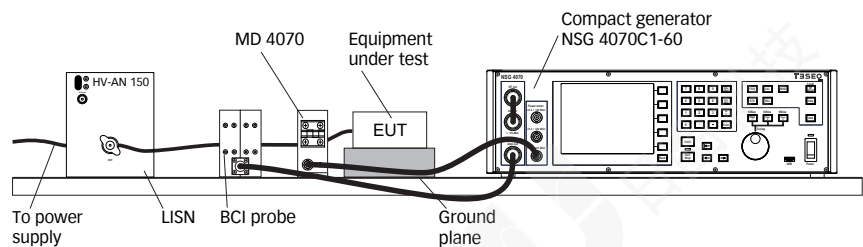

Application for IEC/EN 61000-4-20 up to 1 GHz (example with NSG 4070-45; field probe control requires optional software e.g. CIS)

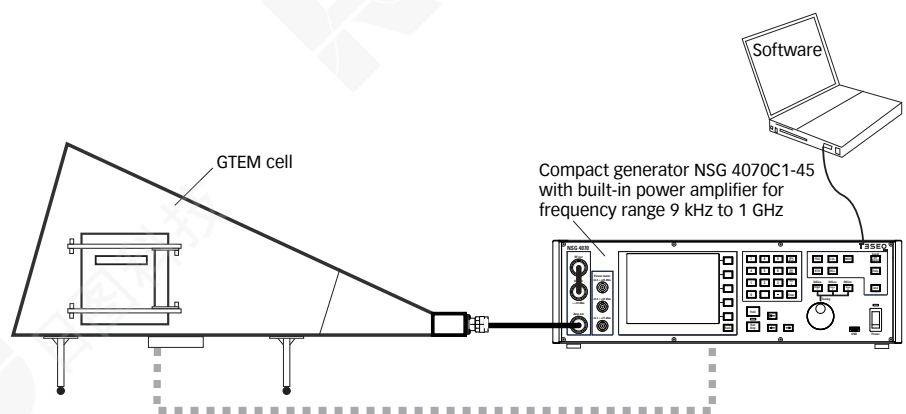

NSG 4070C1 TEST SYSTEM FOR CONDUCTED AND RADIATED IMMUNITY



NSG 4070

Delivery items for the NSG 4070 series

Compact immunity test system NSG 4070, 4 kHz to 1 GHz RF generator and power meter (power amplifier as selected); spare fuses (2); RS232 cable (Nullmodem); USO 4013 (USB to serial/optical converter with 20 m optical cable); LAN cable, crossover, 3 m; keyboard (English); mains cable GB, CH, USA/JP, EU; operating manual



NSG 4070 with rack mounting kit

Model No. and options

Part number	Description
258625	NSG 4070C1-0 Compact immunity test system 4 kHz to 1 GHz RF generator and power meter (without power amplifier)
258624	NSG 4070C1-35 Compact immunity test system, 4 kHz to 1 GHz RF generator and power meter (with 35 W module 150 kHz to 230 MHz)
258621	NSG 4070C1-45 Compact immunity test system, 4 kHz to 1 GHz RF generator and power meter (with 45 W module 9 kHz to 1 GHz)
258620	NSG 4070C1-60 Compact immunity test system, 4 kHz to 1 GHz RF generator, 4 kHz to 1 GHz 5-channel power meter (3 inputs, 2 used internal), 60 W power ampl. module 10 kHz to 400 MHz (>10 W 4 to 10 kHz)
258623	NSG 4070C1-80 Compact immunity test system NSG 4070, 4 kHz to 1 GHz RF generator and power meter (with 80 W module 150 kHz to 230 MHz)
258618	NSG 4070C1-110 Compact immunity test system, 4 kHz to 1 GHz RF generator, 4 kHz to 1 GHz 5-channel power meter (3 inputs, 2 used internal), 110 W power ampl. module 10 kHz to 400 MHz (>10 W 4 to 10 kHz)
97-253290	NSG 4070-TC Traceable calibration (ISO17025), order only with the device
98-253290	NSG 4070-DAkKS DAkKS calibration (ISO17025), order only with the device
253840	NSG 4070 Rack Rack mounting kit for NSG 4070 (red handles) (Not valid for NSG 4070C1-110)
253850	SW 4070 Option for NSG 4070: RF-Switch network 2x SPDT
253104	LE 4070 RF cable set for NSG 4070



NSG 4070C1-110

NSG 4070C1 TEST SYSTEM FOR CONDUCTED AND RADIATED IMMUNITY



SW 4070, RF switch network 2xSPDT



ATN 6150, 6 dB attenuator 150 W

Model No. and options (continued)

235380	ATN 6060 6 dB Attenuator 60 W cw N(f)-N(f)
235376	ATN 6150 6 dB Attenuator 150 W cw N(f)-N(f)
235378	ATN 6200 6 dB Attenuator 200 W cw N(f)-N(f)
257512	icd.control Software License for one generator NSG 4070B-xx, NSG 4070C1-xx

Example icd.control software

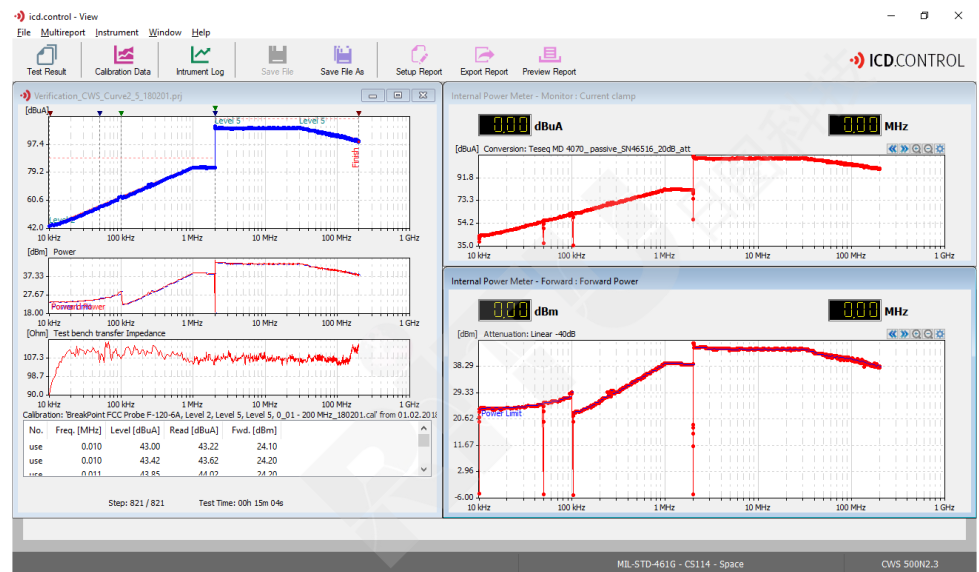

© April 2022 Teseq®
Specifications subject to change without notice.
Teseq® is an ISO-registered company. Its products are designed and manufactured under the strict quality and environmental requirements of the ISO 9001. This document has been carefully checked. However, Teseq® does not assume any liability for errors or inaccuracies.

82-258623 E01 April 2022

日图简介

深圳市日图科技有限公司（简称“日图科技”）创始于2004年，核心业务是为国内企业提供测试设备及相关器材的供应服务，公司客户涵盖制造、科研、教育、电力、能源、通信等众多领域。创业至今，日图科技已经成为国内仪器仪表行业中最大的综合服务供应商之一，日图科技作为行内的领先者，有着高效的供应服务体系，并拥有一支专业的、高素质的服务团队。

目前，日图科技已在深圳、上海、广州、苏州、重庆、杭州、西安、香港等国内电子工业发达地区设立了办事与服务机构，并通过日图科技在全国各地的经销网络，为广大客户提供优质的本地化服务。

日图科技一贯秉承“专业、规范、诚信立业，日日图新”的宗旨，并在实践中不断提升公司的服务能力，为客户提供专业、高效、全面、经济的优质供应服务，顾客满意是日图科技永远追求的目标。

合作伙伴



优势服务

- (1) 产品选型
- (2) 测试解决方案
- (3) 免费测试服务
- (4) 代办计量校准
- (5) 维修维护
- (6) 技术培训
- (7) 物流配送
- (8) 常备应急库存

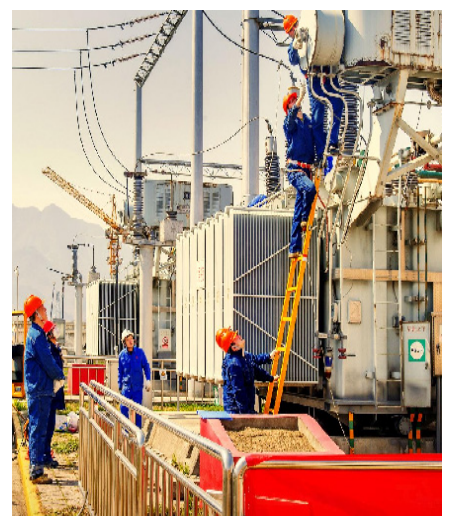

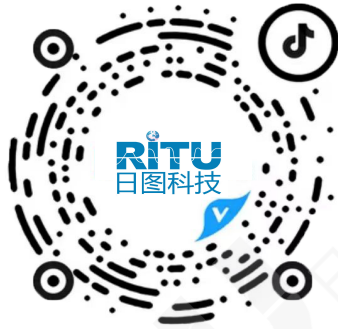

日图抖音号



日图公众号

深圳总部

深圳市南山区留仙大道南山云谷创新产业园二期 6 栋一楼东座
电话：0755-83680722(8 线)

上海分公司

上海市闵行区中春路 8633 弄万科七宝国际 26 幢 701 室
电话：021-33888891/3/5
手机：13564654980

广州分公司

广州市科学城科学大道中 97 号科汇金谷 J 栋东座 808 室
电话：020-31604020
手机：18027340836

西安分公司

陕西省西安市雁塔区长安中路南飞鸿广场 3 号楼 1813 室
手机：15529365365

杭州分公司

浙江省杭州市萧山区盈丰街道鸿宁路 1819 号左右世界 1 幢 1 单元 702-3
电话：0571-86856181
手机：18668225058

重庆分公司

重庆市观音桥茂业东方时代大厦 35 楼 3509 室
电话：023-67904187
手机：13896060852

苏州分公司

苏州苏州工业园区科营路 2 号中新生态大厦 10 楼 1010 室
电话：0512-62515781、0512-62515784
手机：15895400640

香港分公司

香港新界元朗屏厦厦村厦村路 DD125 段 1215-1217lot
电话：+852-24932683

深圳市日图科技有限公司

SHENZHEN RITU SCIENCE TECHNOLOGY CO.,LTD

www.rituchina.com

400-616-5217

广东省深圳市南山区留仙大道南山云谷创新产业园二期 6 栋一楼东座

① 如需所有最新配套资料，请立即与日图科技各地分公司联系。