

Sorensen

35 / 50 / 60 / 120 / 160 / 320 / 500 / 650 kW

i-BEAM Series

5 to 1,000 V

±200 - ±1,000 A

Intelligent-Bidirectional Energy AMplified

High Performance, Bidirectional, Regenerative Programmable DC Power System

Advanced Features

- Single system power up to 650 kW
- Parallel system power up to 1.3 MW
- Bidirectional output voltage up to 1,000 V
- Bidirectional output current up to ±1,000 A, up to ±2,000A in parallel
- Available in 1, 2 or 4 channel configurations
- Multiple channel units share internal DC Bus up to 2MW without drawing additional power from the AC Grid
- Regenerative to 96%
- Large 15-inch color touch panel
- Short circuit proof
- Designed for safety to EN ISO 13849-1
- Dedicated Battery Testing/Simulation Modes
- Seamless transition between source and sink
- High reliability, long life components



Performance. Power. Safety.

The Sorensen™ Intelligent-Bidirectional Energy AMplified (i-BEAM) Series is the newest addition to the AMETEK Programmable Power portfolio of high-power testing solutions. The new i-BEAM series features full DC source and sink capabilities with power levels from 60 kW up to 1.3 MW. The i-BEAM series is fully scalable up to 650 kW and beyond up to 1.3 MW with parallel systems. The available voltage ranges of 80V, 300V, 600V, 800V and 1,000VDC provide full power up to 1,000A within a single system. Single-channel, 2-channel and 4-channel configurations are available.

Control via Front Panel Touchscreen and Digital or Analog Control Interfaces

The i-BEAM Series can be operated from the intuitive, front panel touchscreen that enables the user to easily setup, control and monitor the Output Programming Parameters, Supervisory and Set Point limits, Measurements, and System Settings. Additionally, a variety of communication control interfaces are available including; VNC Ethernet, Modbus, CAN Bus, EtherCAT, Profibus DP, Profinet, LabVIEW, Matlab/Simulink or high-speed Analog control.

i-BEAM Series

Product Data Sheet

User Interface

The i-BEAM includes an intuitive, color TFT touchscreen with a menu-driven interface to control all system settings. Voltage, current, power, and internal resistance values can be set and measured via the touchscreen. The VNC over Ethernet interface allows remote access to the touchscreen.

Voltage and current ramps are programmable and can be stored for repeat use. Under voltage limits can also be set to prevent a deep discharge that could potentially damage a battery pack. Event logs are also available to provide a history of actions, warnings and faults.

User access is password protected with varying levels of permission to system features for up to ten users.



i-BEAM Single-Channel Graphical User Interface

i-BEAM Series

Product Data Sheet



i-BEAM 2-Channel Graphical User Interface

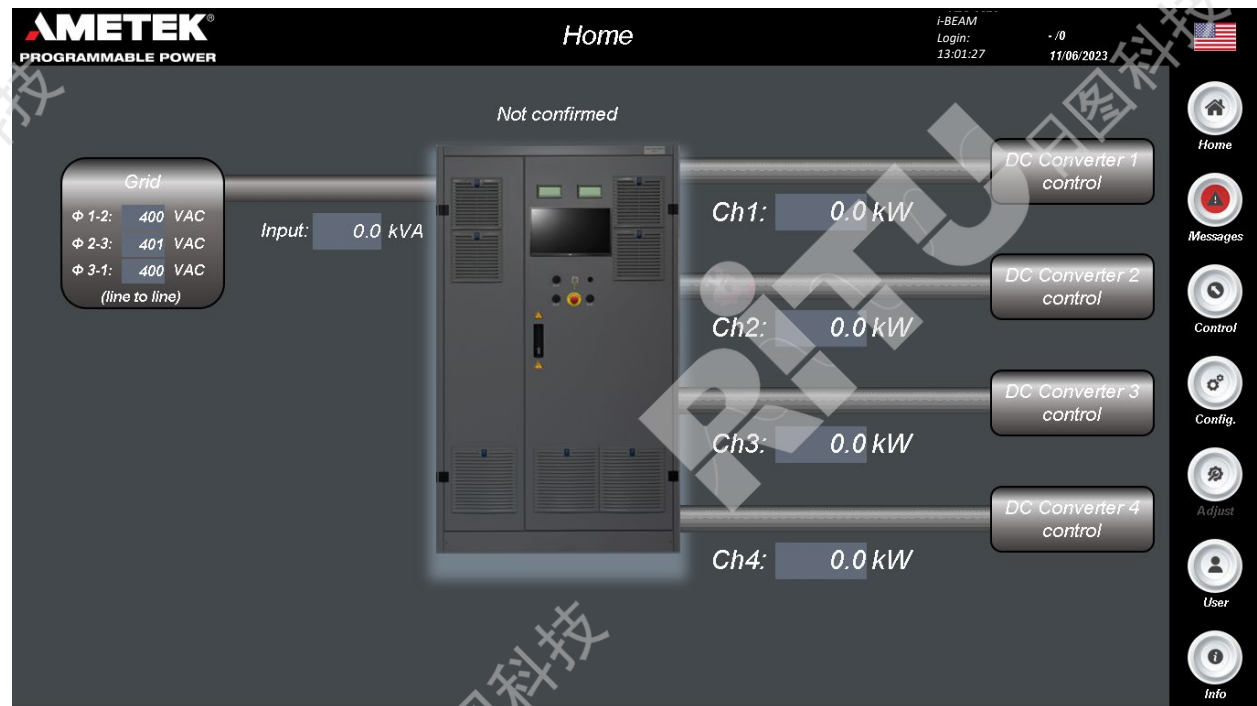

i-BEAM 4-Channel Graphical User Interface

i-BEAM Series

Product Data Sheet

Applications

The i-BEAM Series is designed for testing today's complex, high power electronics for the automotive, energy storage, industrial, and aerospace markets in a variety of applications. This platform covers all test needs through the product life cycle from advance research and development (R&D), to design validation, and production test requirements.

- Battery simulation
- Battery testing (charge/discharge)
- DC motor testing
- Electric powertrain testing
- Fuel cell load testing
- Solar panel testing
- Testing high power fuses, contactors, circuit breakers



Featured Equipment Characteristics

- Battery Simulator and Battery Simulator/Tester options available
- Excellent Dynamic Behavior
- Seamless Source/Sink Transition
- Electrical Isolation to Grid
- High Efficiency
- Short Circuit Proof
 - < 3 kA, < 8kA for 1,000 A systems
- Air Cooled
- Safety Control for Performance Level d (PLd) per ISO 13849-1 and EN 60204-1
- Stop Buttons on Front
- Emergency Stop (ESTOP) Button (Optional)
- Voltmeter on Front
- Main Switch with Fuses for AC Input (Lockable in Off Position)
- DC Output Contactor
- Separate Connections for:
 - DC Voltage Measurement
 - Calibration
 - External Stop
 - External ESTOP

Communication & Control Interfaces

Standard Communication Interfaces

- Virtual Network Computing (VNC) over Ethernet
- Modbus / TCP-IP
- CAN Bus (100 Hz with dbc file)

Optional Communication Interfaces

- EtherCAT
- Profibus
- Profinet
- High speed CAN-Bus (1kHz)
- High speed Analog control
- Interface for Labview
- Interface for Matlab-Simulink

i-BEAM Series

Product Data Sheet

Channel Configurations

Single-Channel

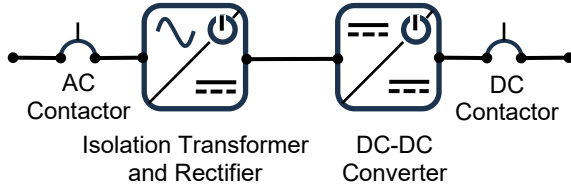

In the Single-Channel configuration power can flow in either direction.

- In source mode the i-BEAM can provide up to 650kW at 1,000V and $\pm 1,000A$.
- In load mode the i-BEAM can sink the same power and regenerate 96% of the energy back to the grid.

Two-Channel

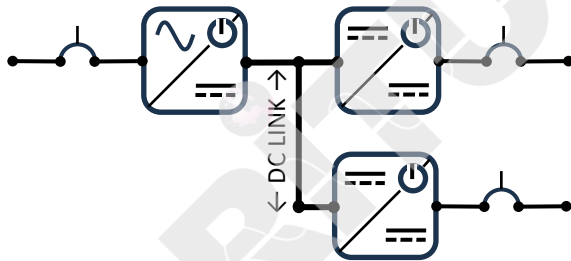

In the Two-Channel configuration power in each channel can flow in either direction.

- If Channel 1 is a source and Channel 2 is a load they can share a common DC Link, up to 2MW without additional power delivery from the AC Grid.
- The two channels may also be paralleled for additional source or load capability.

Four-Channel

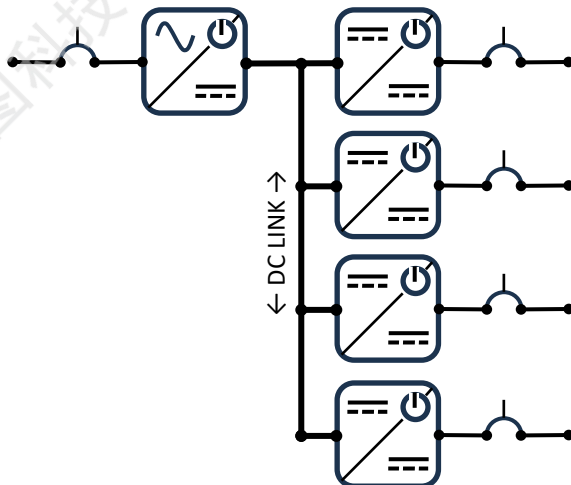

The Four-Channel configuration provides additional flexibility.

- Any channel can be independently configured as a source or load.
- All four channels share the common DC Link, up to 2MW without additional power delivery from the AC Grid.
- Any two channels can be configured in parallel.
- All four channels can be configured in parallel.
- Channels 1 and 2 can be configured as a parallel source while channels 3 and 4 can be configured as a parallel load.

i-BEAM Series

Product Data Sheet

Power Distribution Unit (PDU)

The PDU provides a remote connection between the i-BEAM and a Device Under Test (DUT) in a test cell. The PDU is configured in a free-standing cabinet and includes shutdown and reset controls, voltmeter, status light tower and a door contact that shuts the system down if the cabinet door is opened.

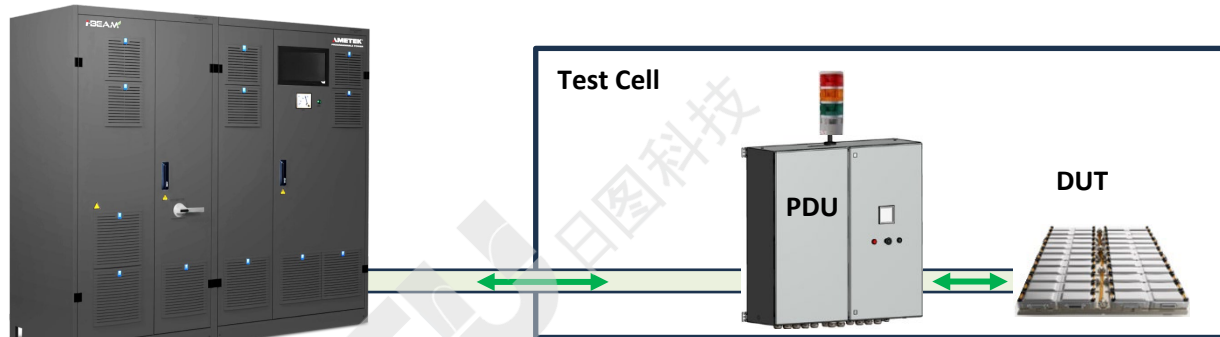

Single Channel i-BEAM with PDU

Additional options are available to add a protection diode, Metallized Polypropylene Capacitors (MKP) to reduce DUT interference, and a short-circuit safety switch for maintenance. The following PDU Options are provided in a separate cabinet to connect to the DUT. They all include a STOP Button, Reset Button, Analog Voltmeter, and a Light Tower for status.

Power Distribution Switch Box (PDSB) and Discharge Unit (DCU)

The Power Distribution Switch Box (PDSB) enables multiple remote switching capabilities between i-BEAM outputs and DUTs. A Discharge Unit (DCU) can also be installed in the PDSB to discharge the energy stored in the DUT in the event of an overvoltage condition or disconnection of the DC output due to System off, AC Mains Failure, System Stop, or E-STOP conditions.

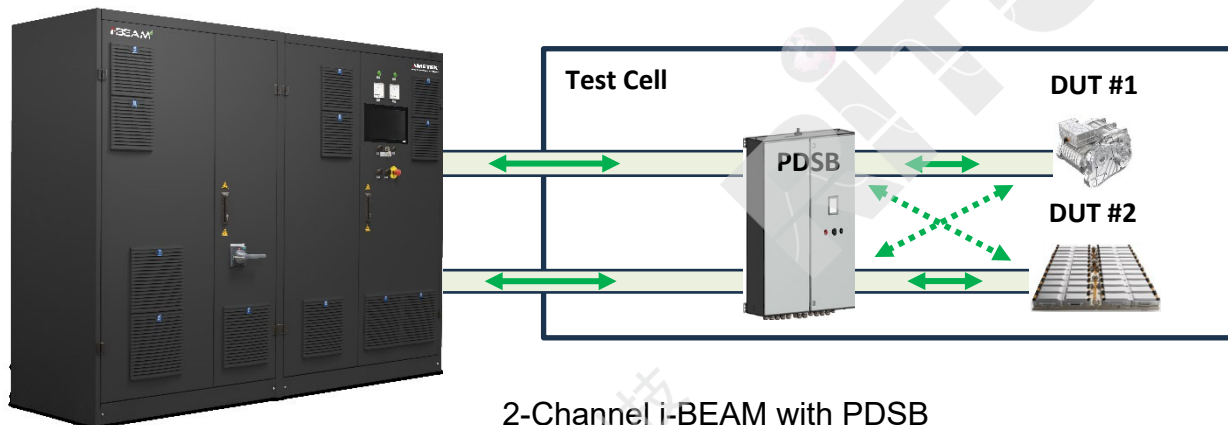

2-Channel i-BEAM with PDSB

Various PDU and PDSB configurations are available for single-channel, 2-channel and 4-channel i-BEAM systems to connect up to four DUTs. Multiple options are available for paralleling two, single-channel i-BEAMs, installation of a DCU, single operation mode via floating contacts, and the installation of insulation monitoring devices. Additional options are available for the 2-Channel and 4-Channel i-BEAM.

i-BEAM Series

Product Data Sheet

Specifications

The i-BEAM Series offers a variety of single-channel, two-channel and four-channel models rated at 35kW to 650kW. Output voltage ratings include 80V, 120V, 300V, 600V, 800V and 1000V, with current ratings of 200A, 600A and 1000A. Refer to order information at the end of this data sheet for exact model numbers.

i-BEAM Series Technical Specifications	
AC Input Specifications	
AC Input Voltage and Frequency	380/400*/440/480/500/690 V $\pm 10\%$, 3-phase, 50/60 Hz $\pm 6\%$
Power Consumption	113 kVA
Maximum Power Loss	12.2 kW
Power Factor (at rated power)	> 0.99 ind.
Total Efficiency at Full Load	Voltage: 94.8 % Current: 89.1%
Current (maximum per phase)	181 A at 400 V -10%
Rated Conditional Short Circuit Current	50 kA
Recommended Pre-Fuse	3 each Class gL/gG 200A
Recommended Cable Cross Section	1 x 95 mm ² per terminal, ≥ 50 mm ² PE
Recommended Cable Lug	M10
Rectifier Implementation	Isolation Transformer (DC terminal is floating)

DC Output Specifications	
Power	35 kW to 650 kW
Voltage	5 – 1,000 VDC
Voltage Ripple	$\leq 0.1\%$ Effective Full Scale
Current	$\pm 1,000$ A
Current Rise Time	< 1 ms (300V – 800V) < 1.3 ms (1,000V)
Current Ripple	$\leq 0.1\%$ Effective Full Scale
Internal Resistance (single operation) ¹	-10 m Ω to +1,000 m Ω
Internal Resistance (parallel operation) ¹	-10 m Ω to +100 m Ω
Accuracy	Voltage/Current: 0.1% Full Scale Power: 0.2% Full Scale of maximum DC power
Tolerance (Static at setpoint value)	Voltage/Current: $\pm 0.1\%$ Full Scale
Tolerance (Dynamic, 0-100% I_{nom} in 3 ms)	Simulation mode < 1%, Test mode < 3%
Measurement Accuracy / Resolution	Voltage/Current: 0.1% Full Scale / 16-bit Resolution
Short Circuit Performance	Short circuit proof ($I_{cw} < 3$ kA, short circuit not for longer time) At 200A/600A: Standard 3 kA (optional 8 kA) At 1000A: Always 8 kA
Oversvoltage Category	II per EN 60664-1
Remote Sense Compensation	5% maximum of rated output voltage

Notes:

- Internal resistance can be reset via interface every 100 ms. New setpoints are calculated every 1 ms and smoothed with a low-pass filter for 10 ms.

i-BEAM Series

Product Data Sheet

Environmental Specifications	
Protection	IP 20 per EN 60529
Protection Class	1 per EN 61140
Operating and Storage Temperature	+5°C to +40°C (+41°F to +104°F); EN 60721-3-3
Transportation Temperature	-45°C to +70°C (-49°F to +158°F); EN 60721-3-2
Operating Humidity	5% - 85% relative humidity without condensation
Operating Altitude	1,000 m (3,280 ft.) with minimum 870 hPa air pressure
Acoustic Noise ²	< 77 dB(a)
Installation Site Recommendations	Operating area with restricted access and installation on a level, Non-Flammable Floor
Cable Entry	From Below
Connection Points	Bottom Front, accessible after doors are open

Notes:

2. The acoustic noise level of the system depends on the load, the loading duration and the environmental conditions; Measurement takes place from front in 1 m high and 1 m distance.

Regulatory Agency Compliance	
EMC Directive	2014/30/EU
EMC Standards	EN 61000-2-4 Class 3, EN 61000-6-2, EN 6100-6-4, EN 55011, EN 61800-3 Cat. C2 (A1)
RoHS Directive	2011/65/EU
General and Safety Standards	EN 60146-1-1, EN 60146-2, EN 62040-1, EN 61439-1, EN 61439-2, EN 62477-1, EN 63000, EN 60529, EN 60721-X, EN 61140
Machine Safety Standards	EN 60204-1, EN 61800-5-2, EN ISO 13849-1, EN ISO 13849-2

Unit Protection	
Output Overvoltage Protection (OVP)	Overvoltage Hardware (HW) Protection. Programmable within voltage range, reaction time less than 1 ms.
	Overvoltage Software (SW) Protection. Software triggered shutdown with a programmable time delay. Limit can be set closer to the maximum voltage level but should be less than the Overvoltage HW set point.
Output Current Limit Protection	Overcurrent (source) and Undercurrent (sink) are programmable within the current range.
Reverse Polarity Protection	Reverse polarity protection active when the DC Converter is off and detected by the sense lines.
AC Input Protection	Automatic shutdown if AC Inputs fall out of nameplate specifications for voltage, frequency or phase loss.
Overtemperature Protection (OTP)	Automatic Overtemperature Protection shutdown when internal component temperature exceeds +40°C (+104°F).

i-BEAM Series

Product Data Sheet

Cabinet Dimensions and Weights

Typical cabinet dimensions and weights. Actual dimensions and weights vary by system configuration and options. All cabinets require a minimum of 300 mm (11.8 inch) clearance to the ceiling.

- i-BEAM configurations of 320kW and higher require additional cabinets.

Cabinet No.	Width	Depth	Height	Weight
1	1,000 mm (39.4 inch)	800 mm (31.5 inch)	2,000 mm (78.8 inch)	1,000 kg (2,205 lbs.)
2	1,200 mm (47.3 inch)	800 mm (31.5 inch)	2,000 mm (78.8 inch)	900 kg (1,984 lbs.)
3	1,200 mm (47.3 inch)	800 mm (31.5 inch)	2,000 mm (78.8 inch)	900 kg (1,984 lbs.)



i-BEAM Series

Product Data Sheet

Order Information:

Model Number Description:

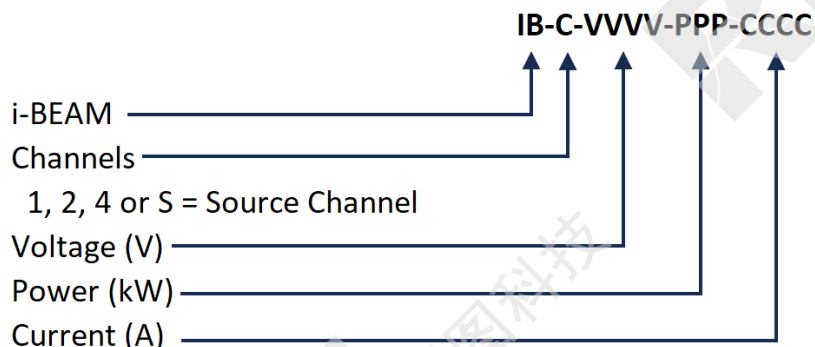

Single Channel Models

i-BEAM Series Single Channel Output Models			
MODEL	Voltage (V)	Power (kW)	Current (A)
IB-1-80-35-1000	80	35	1000
IB-1-120-50-1000	120	50	1000
IB-1-300-60-200	300	60	200
IB-1-300-60-600	300	60	600
IB-1-300-60-1000	300	60	1000
IB-1-300-120-600	300	120	600
IB-1-300-120-1000	300	120	1000
IB-1-300-160-1000	300	160	1000
IB-1-600-60-200	600	60	200
IB-1-600-60-600	600	60	600
IB-1-600-60-1000	600	60	1000
IB-1-600-100-200	600	100	200
IB-1-600-100-600	600	100	600
IB-1-600-100-1000	600	100	1000
IB-1-600-160-600	600	160	600
IB-1-600-160-1000	600	160	1000
IB-1-600-250-600	600	250	600
IB-1-600-250-1000	600	250	1000
IB-1-600-320-600	600	320	600
IB-1-600-320-1000	600	320	1000
IB-1-600-400-1000	600	400	1000
IB-1-600-500-1000	600	500	1000
IB-1-800-100-200	800	100	200
IB-1-800-100-600	800	100	600
IB-1-800-100-1000	800	100	1000

i-BEAM Series Single Channel Output Models			
MODEL	Voltage (V)	Power (kW)	Current (A)
IB-1-800-160-200	800	160	200
IB-1-800-160-600	800	160	600
IB-1-800-160-1000	800	160	1000
IB-1-800-250-600	800	250	600
IB-1-800-250-1000	800	250	1000
IB-1-800-320-600	800	320	600
IB-1-800-320-1000	800	320	1000
IB-1-800-400-1000	800	400	1000
IB-1-800-500-1000	800	500	1000
IB-1-1000-60-200	1000	60	200
IB-1-1000-100-200	1000	100	200
IB-1-1000-100-600	1000	100	600
IB-1-1000-100-1000	1000	100	1000
IB-1-1000-160-200	1000	160	200
IB-1-1000-160-600	1000	160	600
IB-1-1000-160-1000	1000	160	1000
IB-1-1000-250-600	1000	250	600
IB-1-1000-250-1000	1000	250	1000
IB-1-1000-320-600	1000	320	600
IB-1-1000-320-1000	1000	320	1000
IB-1-1000-400-600	1000	400	600
IB-1-1000-400-1000	1000	400	1000
IB-1-1000-500-600	1000	500	600
IB-1-1000-500-1000	1000	500	1000
IB-1-1000-650-1000	1000	650	1000

i-BEAM Series

Product Data Sheet

Multichannel Models - 300V Outputs

i-BEAM Series 300V Multichannel Output Models				
MODEL	Channels	Voltage (V)	Power (kW)	Current (A)
IB-2-300-60-200 (Min. 15kW Source Required)	2	300	60	200
IB-4-300-60-200 (Min. 30kW Source Required)	4	300	60	200
IB-2-300-120-600 (Min. 45kW Source Required)	2	300	120	600
IB-4-300-120-600 (Min. 90kW Source Required)	4	300	120	600
IB-2-300-160-1000 (Min. 75kW Source Required)	2	300	160	1000
IB-4-300-160-1000 (Min. 150kW Source Required)	4	300	160	1000

For each product ordered above select one DC Rectifier Source from the list below that meets the Minimum Source Requirement.

i-BEAM Series 300V DC Rectifier Source Models		
MODEL	Voltage (V)	Power (kW)
IB-S-300-60	300	60
IB-S-300-120	300	120
IB-S-300-160	300	160

Multichannel Models - 600V Outputs

i-BEAM Series 600V Multichannel Output Models				
MODEL	Channels	Voltage (V)	Power (kW)	Current (A)
IB-2-600-100-200 (Min. 30kW Source Required)	2	600	100	200
IB-4-600-100-200 (Min. 60kW Source Required)	4	600	100	200
IB-2-600-320-600 (Min. 90kW Source Required)	2	600	320	600
IB-4-600-320-600 (Min. 180kW Source Required)	4	600	320	600
IB-2-600-500-1000 (Min. 150kW Source Required)	2	600	500	1000
IB-4-600-500-1000 (Min. 300kW Source Required)	4	600	500	1000

For each product ordered above select one DC Rectifier Source from the list below that meets the Minimum Source Requirement.

i-BEAM Series 600V DC Rectifier Source Models		
MODEL	Voltage (V)	Power (kW)
IB-S-600-60	600	60
IB-S-600-100	600	100
IB-S-600-160	600	160
IB-S-600-250	600	250
IB-S-600-320	600	320
IB-S-600-400	600	400
IB-S-600-500	600	500

i-BEAM Series

Product Data Sheet

Multichannel Models - 800V Outputs

i-BEAM Series 800V Multichannel Output Models				
MODEL	Channels	Voltage (V)	Power (kW)	Current (A)
IB-2-800-100-200 (Min. 40kW Source Required)	2	800	100	200
IB-4-800-100-200 (Min. 80kW Source Required)	4	800	100	200
IB-2-800-400-600 (Min. 120kW Source Required)	2	800	400	600
IB-4-800-400-600 (Min. 240kW Source Required)	4	800	400	600
IB-2-800-500-1000 (Min. 200kW Source Required)	2	800	500	1000
IB-4-800-500-1000 (Min. 400kW Source Required)	4	800	500	1000

For each product ordered above select one DC Rectifier Source from the list below that meets the Minimum Source Requirement.

i-BEAM Series 800V DC Rectifier Source Models		
MODEL	Voltage (V)	Power (kW)
IB-S-800-100	800	100
IB-S-800-160	800	160
IB-S-800-250	800	250
IB-S-800-320	800	320
IB-S-800-400	800	400
IB-S-800-500	800	500

Multichannel Models - 1000V Outputs

i-BEAM Series 1000V Multichannel Output Models				
MODEL	Channels	Voltage (V)	Power (kW)	Current (A)
IB-2-1000-250-200 (Min. 50kW Source Required)	2	1000	250	200
IB-4-1000-250-200 (Min. 100kW Source Required)	4	1000	250	200
IB-2-1000-500-600 (Min. 150kW Source Required)	2	1000	500	600
IB-4-1000-500-600 (Min. 300kW Source Required)	4	1000	500	600
IB-2-1000-650-1000 (Min. 250kW Source Required)	2	1000	650	1000
IB-4-1000-650-1000 (Min. 500kW Source Required)	4	1000	650	1000

For each product ordered above select one DC Rectifier Source from the list below that meets the Minimum Source Requirement.

i-BEAM Series 1000V DC Rectifier Source Models		
MODEL	Voltage (V)	Power (kW)
IB-S-1000-100	1000	100
IB-S-1000-160	1000	160
IB-S-1000-250	1000	250
IB-S-1000-320	1000	320
IB-S-1000-400	1000	400
IB-S-1000-500	1000	500
IB-S-1000-650	1000	650

i-BEAM Series

Product Data Sheet

i-BEAM Series Options

i-BEAM Series Options	
OPTION MODEL	DESCRIPTION
Cabinet Options Required for USA / Canada	
IB-CAB-USA-100	UL-489 Compliant Cabinet, 100kW Version USA / Canada
IB-CAB-USA-160	UL-489 Compliant Cabinet, 160kW Version USA / Canada
IB-CAB-USA-250	UL-489 Compliant Cabinet, 250kW Version USA / Canada
IB-CAB-USA-320	UL-489 Compliant Cabinet, 320kW Version USA / Canada
IB-CAB-USA-400	UL-489 Compliant Cabinet, 400kW Version USA / Canada
IB-CAB-USA-500	UL-489 Compliant Cabinet, 500kW Version USA / Canada
IB-CAB-USA-650	UL-489 Compliant Cabinet, 650kW Version USA / Canada
IB-PDSB-CAB-USA	UL-489 Compliant Power Distribution Switch Box USA / Canada
IB-AC-IN-480	480VAC $\pm 10\%$, 3-Phase Input; 480VAC $\pm 10\%$ standard mains voltage of 3 / PE, for Single-Channel Units.
IB-M-AC-IN-480	480VAC $\pm 10\%$, 3-Phase Input; 480VAC $\pm 10\%$ standard mains voltage of 3 / PE, for 2-Channel and 4-Channel Units.
Interface and Control Communication Options	
IB-IF-ETHERCAT	EtherCAT Interface (2 each RJ45 Connectors); 100 Mbit/s Transmission Rate
IB-IF-PROFIBUS	Profibus Interface (9-pin DSUB Connector); 12 Mbit/s Transmission Rate
IB-IF-PROFINET	Profinet Interface (2 each RJ45 Connectors); 12 Mbit/s Transmission Rate
IB-IF-HSCAN	High-Speed CAN Bus Interface (1 kHz Rate)
IB-IF-SCPI	SCPI Interface, Single Channel Units Only.
IB-CAN-FD	Interface "CAN-FD" CAN-FD bus interface with a cycle time of 1 ms (1 kHz) for setpoint setting for highly dynamic processes. - additional converter from CAN-FD to CAN 2.0 AB built-in - cycle time setpoint setting of 1 ms for UDC, I+DC, I-DC - Cycle time of measured value transmission of 1 ms for UDC, IDC - Cycle time of other control commands 10 ms Not valid with parallel units. Interface has no galvanic isolation. Price / channel
IB-IF-ANALOG-IN	Analog Input Signal (Voltage = 0-10V Full Scale; Current = $\pm 10V$ Full Scale)
IB-IF-ANALOG-OUT	Analog Output Signal (Voltage = 0-10V Full Scale; Current = $\pm 10V$ Full Scale)
IB-IF-HS-ANALOG	High-Speed Analog Control ($\pm 10V = \pm$ Full Scale) for Single Channel Units Only
IB-RC-100MB-VPN	Remote Control VPN for AMETEK Maintenance
IB-RC-100-RENT	Rental fee for remote service module (Tosi-Box) - Provision of the remote service module to install a software update on the B&R controller.
IB-REMOTE-UPDATE	Software Adjustment via Remote Control Please note: Lead time approx. 2 weeks
IB-TEAM-VIEW	Software adjustment via Teamviewer For the adjustment of the software, a "communication PC" with Internet access is required on site. Please note: Lead time approx. 2 weeks
IB-IF-LABVIEW	LabVIEW (NI) Interface with USB to CAN Converter
IB-IF-MATLAB	MATLAB/Simulink Interface, includes PC and B&R Automation Studio Software
Insulation Monitoring Options	

i-BEAM Series

Product Data Sheet

i-BEAM Series Options	
OPTION MODEL	DESCRIPTION
IB-IMD	Insulation Monitoring Device – Single Channel Unit Only; Monitors the DUT and Shuts Down the Output when Leakage Resistance falls below 100k ohms. Bender ISOMETER® P/N: iso685. Can be disabled in Systems Settings menu.
IB-IMD-2CH	Insulation Monitoring Device with Selective Shutdown for 2-Channel Unit Only; Monitors the DUT and Shuts Down the Output when Leakage Resistance falls below 100k ohms. Bender ISOMETER® P/N: iso685. Can be disabled in Systems Settings menu. Special software and PDSB required.
IB-IMD-4CH	Insulation Monitoring Device with Selective Shutdown for 4-Channel Unit Only; Monitors the DUT and Shuts Down the Output when Leakage Resistance falls below 100k ohms. Bender ISOMETER® P/N: iso685. Can be disabled in Systems Settings menu. Special software and PDSB required.
IB-1-ISO-5M	Increase insulation resistance of 1-Channel to > 5 MΩ - Adjustment of series resistors of measuring transducer rectifier - Adjustment of series resistances of measuring transducer DC converter.
IB-2-ISO-5M	Increase insulation resistance of 2-Channel to > 5 MΩ - Adjustment of series resistors of measuring transducer rectifier - 2 x Adjustment of series resistances of measuring transducer DC converter.
IB-4-ISO-5M	Increase insulation resistance of 4-Channel to > 5 MΩ - Adjustment of series resistors of measuring transducer rectifier - 4 x Adjustment of series resistances of measuring transducer DC converter.
Test Application Options	
IB-BAT-S-300	Battery Simulator for 300V Systems. One each required per channel. For systems ≤ 600A the short-time withstand DC Output Capacitors are recommended, IB-DC-1000. Output filter is optimized for battery simulation by additional MKP capacitors.
IB-BAT-S-600	Battery Simulator for 600V Systems. One each required per channel. For systems ≤ 600A the short-time withstand DC Output Capacitors are recommended, IB-DC-1000. Output filter is optimized for battery simulation by additional electrolytic capacitors.
IB-BAT-S-800	Battery Simulator for 800V Systems. One each required per channel. For systems ≤ 600A the short-time withstand DC Output Capacitors are recommended, IB-DC-1000. Output filter is optimized for battery simulation by additional electrolytic capacitors.
IB-BAT-S-1000	Battery Simulator for 1000V Systems. One each required per channel. For systems ≤ 600A the short-time withstand DC Output Capacitors are recommended, IB-DC-1000. Output filter is optimized for battery simulation by additional electrolytic capacitors.
IB-BAT-TS-300	Battery Tester/Simulator for 300V Systems. One each required per channel. For systems ≤ 600A the short-time withstand DC Output Capacitors are recommended, IB-DC-1000. Output filter is optimized by switching in capacitors for the tester or simulator modes.
IB-BAT-TS-600	Battery Tester/Simulator for 600V Systems. One each required per channel. For systems ≤ 600A the short-time withstand DC Output Capacitors are recommended, IB-DC-1000. Output filter is optimized by switching in capacitors for the tester or simulator modes.
IB-BAT-TS-800	Battery Tester/Simulator for 800V Systems. One each required per channel. For systems ≤ 600A the short-time withstand DC Output Capacitors are recommended, IB-DC-1000. Output filter is optimized by switching in capacitors for the tester or simulator modes.

i-BEAM Series

Product Data Sheet

i-BEAM Series Options	
OPTION MODEL	DESCRIPTION
IB-BAT-TS-1000	Battery Tester/Simulator for 1000V Systems. One each required per channel. For systems $\leq 600A$ the short-time withstand DC Output Capacitors are recommended, IB-DC-1000. Output filter is optimized by switching in capacitors for the tester or simulator modes.
IB-DC-1000	Output Contactors with Increased Short-time Withstand Current. One each required per channel. Vnom 1500V, thermal continuous current 1000A, short-time withstand current ICW 8kA.
IB-DUAL-CR-100-10	Current Range Switching. Single-Channel only. Range 1: 100% of nominal current, Range 2: 10% of nominal current for measuring low currents only. Switch change only when output is off.
IB-MEAS-05-CERT	0.05% Measurement Accuracy, Test Certificate Included. Required for each channel.
IB-FC-DEXT-1000	Protection Diode in a Separate Cabinet. Maximum Rating 1000V / 1000A, for Fuel Cell Testing. Cabinet dimensions: 600 x 800 x 2000mm (23.6 x 31.5 x 78.8 inch). Weight: 200kg (441 lbs.).
IB-FC-DINT-1000	Protection Diode Mounted in Cabinet. Only for 2-Channel or 4-Channel systems. Maximum Rating 1000V / 1000A, for Fuel Cell Testing. Cabinet width increases by 200mm (7.9 inch).
IB-PCD-1	Parallel Control Device. Upgrade to allow parallel operation of two single-channel units with same voltage/current rating. One required for each single-channel unit. Not available for 2-Channel and 4-Channel systems.
IB-PL-D-PAR	Safety Master Control for Parallel Operation for Performance Level 'd', mounted in an external cabinet. Cabinet dimensions: 600 x 250 x 800mm (23.6 x 9.8 x 31.5 inch).
IB-PL-D-PAR	Safety Master Control for Parallel Operation Required to achieve "Performance Level d" in parallel operation of two i-BEAMs. - Dimensions: 600 x 250 x 800mm (23.6" x 9.8" x 31.5") - Safety control with operating mode selector switch (single and parallel operation)
IB-PL-D-DSB	Safety Master Control for Parallel Operation (PDSB) for Performance Level 'd', Installed in the Power Distribution Switch Box with 2 inputs and 1 output, ordered separately.
Safety and Cabinet Options	
IB-ESTOP-PL-D	Change of safe shutdown time (Emergency Stop) Standard setting: 5 sec. Range is 0.5 to 100sec. Includes the verification of safety controller software to confirm "Performance level d" per DIN EN 13849.
IB-ESTOP-2CON	Emergency Stop (E-STOP) Switch (yellow/red) with Protective Collar installed in control cabinet door. Includes two potential-free normally open contact connections, contacts close when E-STOP activated.
IB-ESTOP-DOOR-CON	Door Closed Contacts. E-STOP activated when cabinet doors open, E-STOP cannot be reset while doors are open. Only available on 2-Channel and 4-Channel systems. One required for each cabinet.
IB-MAG-SAFE-DOOR	Magnetic Door Safety Interlocks. Doors cannot be opened while AC Mains switch is on. System cannot start with doors open. Only available on 2-Channel and 4-Channel systems. One required for each cabinet.
IB-DOOR-LOCK	Keyed Door Locks per Cabinet.
IB-CAB-LAMP	Cabinet Lamp. Cabinet lighting with motion sensor mounted on the cabinet ceiling in the front area. One per cabinet.

i-BEAM Series

Product Data Sheet

i-BEAM Series Options	
OPTION MODEL	DESCRIPTION
IB-CAB-BASE-200	Cabinet Base Frame. Raises the cabinet base 200mm (7.87 inch) to accommodate large cross-section cable entry. One per cabinet.
IB-CAB-WHEELS	Cabinet Wheels. Four wheeled castors per cabinet, two with stop latches. Adds 182 mm (7.17 inch) to cabinet height. For Rittal cabinet height is increased by 270mm (10.6 inch).
IB-LIFT-LUGS	Add 4 Lifting Lugs per Cabinet per DIN 580/582. Not available for cabinets > 1000 kg (2,204 lbs.).
External Capacitor Box Options	
IB-CBOX-800-19800	External Capacitor Box, 800 V, 19,800 uF, plastic enclosure, includes discharge resistors and 5 m (16 foot) cables with M10 ring lugs for connection to DUT.
IB-CBOX-1000-8100	External Capacitor Box, 1000 V, 8100 uF, plastic enclosure, includes discharge resistors and 5 m (16 foot) cables with M10 ring lugs for connection to DUT.
IB-CBOX-P-1000-20000	External Capacitor Box, 1000 V, 20,000 uF, plastic enclosure, includes discharge resistors and 5 m (16 foot) cables with M10 ring lugs for connection to DUT.
IB-CBOX-800-20360	External Capacitor Box, 800 V, 20,360 uF, metal enclosure, includes discharge resistors and 5 m (16 foot) cables with M10 ring lugs for connection to DUT.
IB-CBOX-1000-9660	External Capacitor Box, 1000 V, 9,660 uF, metal enclosure, includes discharge resistors and 5 m (16 foot) cables with M10 ring lugs for connection to DUT.
IB-CBOX-1100-2500	External Capacitor Box, 1100V, 2500 uF, metal enclosure, includes discharge resistors and 5 m (16 foot) cables with M10 ring lugs for connection to DUT.
IB-CBOX-M-1100-5800	External Capacitor Box, 1100V, 5800 uF, metal enclosure, includes discharge resistors and 5 m (16 foot) cables with M10 ring lugs for connection to DUT.
Power Distribution Switch Box Options for Single Channel Units (No Test Bench Switching)	
IB-PDSB-1-1-1KA-2	PDSB 1000V / 1000A (1 Input / 1 Output; space for 2 DCU) additional cabinet (PDSB) for i-BEAM for installation of 2 DCUs - Empty space for the installation of max. 2 DCU - Dimensions: 600x800x2000mm (23.6x31.5x78.7 inches)
IB-PDSB-2-1-2KA-2	PDSB 1000V / 2000A (2 Input / 1 Output; space for 2 DCU) additional control cabinet (PDSB) for paralleling two i-BEAMs and for installation of 2 DCUs - Empty space for the installation of max. 2 DCU - Dimensions: 800x800x2000mm (31.5x31.5x78.7 inches) Note: To achieve DIN EN 13849 performance level 'd' order Safety Control IB-SAFE-MST-PDSB
IB-SAFE-MST-PDSB	Safety Master Control for Parallel Operation (PDSB) Required to achieve Performance Level 'd' in parallel operation of two i-BEAMs. - Installation in PDSB with 2 Input / 1 Output (needs to be ordered separately)
Power Distribution Switch Box Options for Single Channel Units (with Test Bench Switching)	
IB-PDSB-E-1-2-600-2	PDSB with contactor 1000V / 600A (1 Input / 2 Output; space for 2 DCU) additional control cabinet (PDSB) with the hardware equipment for power distribution from one i-BEAM to two test stands / DUT and the installation of max. 2 DCU consisting of: - Dimensions: 800x800x2000mm (31.5x31.5x78.7 inches) - 4 changeover contactors (rated current 600A)

i-BEAM Series

Product Data Sheet

i-BEAM Series Options															
OPTION MODEL	DESCRIPTION														
	- 4 changeover relays for sense measuring cable														
IB-PDSB-E-1-2-1K	<p>PDSB with contactor 1000V / 1000A (1 Input / 2 Output) Additional control cabinet (PDSB) with the hardware equipment for power distribution from one i-BEAM to two test stands / DUT and the installation of max. 4 DCU consisting of:</p> <ul style="list-style-type: none"> - Dimensions: 1200x800x2000mm (47.2x31.5x78.7 inches) - 4 changeover contactors (rated current 1000A) - 4 changeover relays for sense measuring cable - Switching contactors, switching relays and display elements wired to terminals <p>Note: PLd only for version with option "IB-PDSB-S-1-2-PL-6" A standard PDU can only be connected with the option "IB-PDSB-S-1-2-PL-6"</p>														
IB-PDSB-S-1-2-PL-6	<p>PDSB "safety control" (1 Input / 2 Output) Installation of the safety controller to achieve performance level "d" per DIN EN 13849 in the PDSB 1 input / 2 outputs consisting of:</p> <ul style="list-style-type: none"> - Safety control, operating and display elements for controlling the output contactors according to the selected operating mode - Power supply for controlling the change-over contactors (load circuit) and change-over relay (sensor measuring line) <table border="1" data-bbox="509 940 1269 1165"> <thead> <tr> <th rowspan="2">Operation mode</th> <th colspan="2">i-BEAM System</th> </tr> <tr> <th>TC 1 / DUT 1</th> <th>TC 2 / DUT 2</th> </tr> </thead> <tbody> <tr> <td>1</td> <td>Contactors open</td> <td>Contactors open</td> </tr> <tr> <td>2</td> <td>xxxkW/1000V/1000A</td> <td>Contactors open</td> </tr> <tr> <td>3</td> <td>Contactors open</td> <td>xxxkW/1000V/1000A</td> </tr> </tbody> </table>	Operation mode	i-BEAM System		TC 1 / DUT 1	TC 2 / DUT 2	1	Contactors open	Contactors open	2	xxxkW/1000V/1000A	Contactors open	3	Contactors open	xxxkW/1000V/1000A
Operation mode	i-BEAM System														
	TC 1 / DUT 1	TC 2 / DUT 2													
1	Contactors open	Contactors open													
2	xxxkW/1000V/1000A	Contactors open													
3	Contactors open	xxxkW/1000V/1000A													

i-BEAM Series

Product Data Sheet

Warranty Statement:

AMETEK Programmable Power Inc. warrants its products to be free from defects in material and workmanship. The warranty period is from the date of original shipment of the product to the original purchaser (see website for warranty periods by product). i-BEAM Series comes with a **two (2)** year warranty.

Note: All specifications subject to change without notice.